

BIKE PARKING GUIDELINES

*January 2021
Version 2.1*

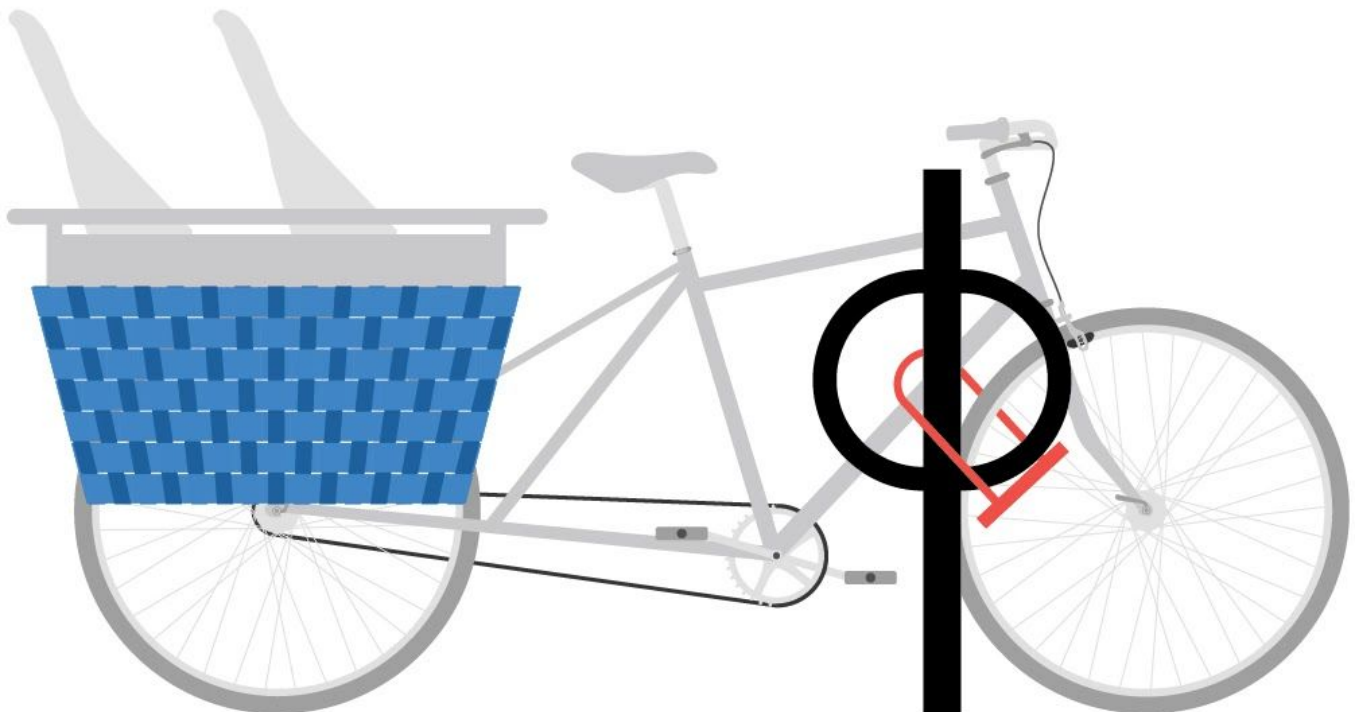

CONTENTS

1. INTRODUCTION	
I. PURPOSE	3
II. APPLICABILITY	3
III. BIKE STYLES AND ATTACHMENTS	4
2. RATES	5
3. RACK SELECTION	6
I. PERFORMANCE CRITERIA	6
II. CITY OF BOSTON STANDARD RACK	7
III. INVERTED U RACKS	8
IV. TWO-TIER RACKS	8
V. PROHIBITED RACKS	9
4. VISITOR PARKING	11
I. LOCATION	
II. RACK TYPE	11
III. CLEARANCES	11
5. EMPLOYEE/RESIDENT PARKING	13
I. LOCATION AND ACCESS	13
II. RACK TYPES	14
III. CLEARANCES	14
IV. SECURITY	16
V. SIGNAGE	16
VI. PRICING	16
VII. ELECTRIC BIKE CHARGING	16
6. SHOWERS AND CHANGING FACILITIES	17
7. BIKESHARE	18
I. STATION CONFIGURATIONS	18
II. LOCATION AND ACCESS	18
III. CLEARANCES	18
8. APPENDIX: INSTALLING RACKS	20

1. INTRODUCTION

I. PURPOSE

With these guidelines, we aim to ensure the provision of **adequate, secure, and convenient** bike parking for residents, workers, students, and visitors in the City of Boston.

To help support the growth in bike ridership called for in Go Boston 2030¹, people must have confidence that their journey will end with a safe and convenient place to park their bike—whether at their residence, place of employment, or other everyday destination. This includes shorter-term **visitor parking** as well as longer-term **employee/resident parking** in secure, indoor locations. Additionally, bike commuters need **showers and changing facilities** to bike year-round without sacrificing personal hygiene. Finally, a growing number of people rely on the convenience and affordability of Boston's **bikeshare** system.

Taken together, these accommodations reduce barriers to biking for transportation and recreation. Their provision will help us reach the City's goal of quadrupling the number of people who bike to work.

II. APPLICABILITY

Every building in the City of Boston should include these accommodations. They are required in all projects subject to Transportation Access Plan Agreements (TAPAs) and Site Plan Review administered by the Boston Transportation Department (BTD). They also are required for all projects subject to the Boston Planning and Development Agency (BPDA)'s Article 80 Small and Large Project Review, including Compact Living projects. Proponents must provide a **bike parking plan** along with all project filings, including the Small Project Review Application, Project Notification Form, and Draft Project Impact Report. Bike parking plans should include the following:

- ▶ **Quantities, locations, and layouts** for proposed visitor bike parking, employee/resident bike parking, bikeshare stations, and showers and changing facilities
- ▶ **Specifications** for all proposed bike racks
- ▶ An identified **primary access route** to proposed employee/resident bike parking

Flexibility may be granted in cases of undue hardship, determined on a case-by-case basis and after a good-faith effort to meet the guidelines in full. A finding of undue hardship will take into account a project's size, site, and financing.

¹ Go Boston 2030: Vision and Action Plan. Accessed December 4, 2019. [boston.gov/sites/default/files/document_files/2019/06/go_boston_2030_-_full_report.pdf](https://www.boston.gov/sites/default/files/document_files/2019/06/go_boston_2030_-_full_report.pdf).

III. BIKE STYLES AND ATTACHMENTS

Bikes come in many shapes and sizes that serve a variety of **ages, abilities, and transportation needs**. We aim to accommodate the following common bike styles and attachments.

FIGURE 1: COMMON BIKE STYLES

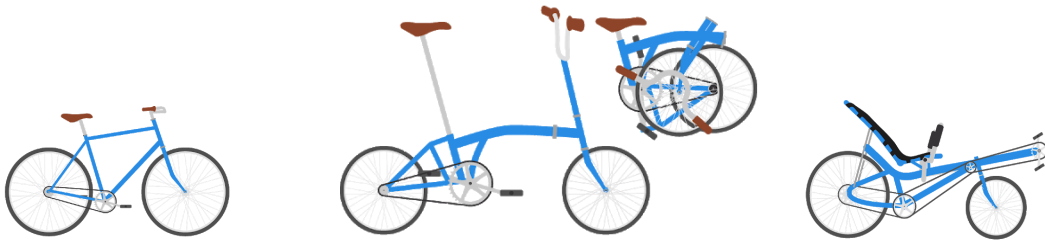

TWO-WHEELED BIKE

FOLDING BIKE

ADAPTIVE BIKE

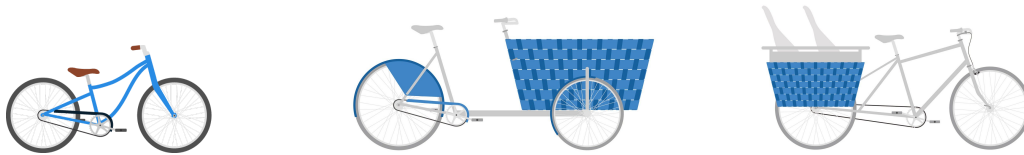

KID'S BIKE

CARGO BIKE

LONG-TAILED BIKE

FIGURE 2: COMMON BIKE ATTACHMENTS

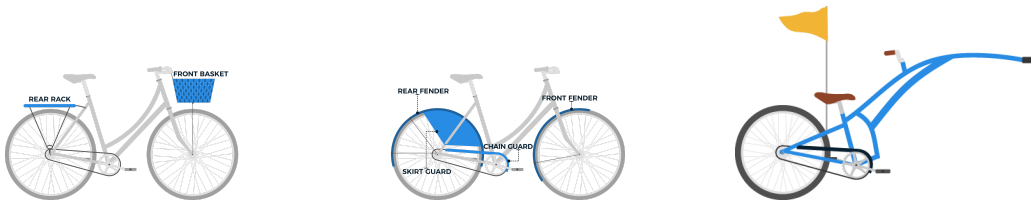

BASKETS AND RACKS

FENDERS AND GUARDS

TRAILER BIKE

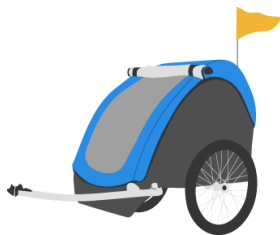

TRAILER



BABY SEAT

2. RATES

Every building in the City of Boston should include bike accommodations at the rates detailed in Table 1. These rates are required in all projects subject to BTDA's TAPAs and Site Plan Review as well as BPDA's Article 80 Small and Large Project Review. Each rate is tied to a direct and calculable indicator of cycling demand. Calculate rates proportional to the mix of uses. Always round up.

TABLE 1: REQUIRED RATES FOR DIFFERENT LAND USES

	BUILDING USE	VISITOR PARKING SPACES[*] <i>(short-term)</i>	EMPLOYEE/ RESIDENT PARKING SPACES[†] <i>(long-term)</i>	SHOWERS[‡]	LOCKERS[‡]	BIKESHARE STATIONS[§]	BIKESHARE CONTRIBUTION
RESIDENTIAL	1 to 3-Unit	N/A	1 per unit	N/A	N/A	N/A	N/A
	Multi-Unit (4 or more units)	1 per 5 units (4 minimum)	1 per unit (0.5 per unit for senior housing)	N/A	N/A	Space for a 15-dock or 19-dock station	\$275 per unit (\$75K or \$49K minimum)
	Institutional Housing (College, university, and other)	1 per 20 beds (4 minimum)	1 per 2 beds	N/A	N/A	Space for a 15-dock or 19-dock station	\$137.50 per bed (\$75K or \$49K minimum)
NON-RESIDENTIAL	Office/Admin	1 per 20,000 sf (6 minimum)	1 per 2,500 sf	1 per 60,000 sf (1 minimum)	1 per 6,000 sf (1 minimum)	Space for a 15-dock or 19-dock station	\$0.28 per sf (\$75K or \$49K minimum)
	Industrial	1 per 40,000 sf (6 minimum)	1 per 12,000 sf (6 minimum)	1 per 480,000 sf (1 minimum)	1 per 48,000 sf (1 minimum)	Space for a 15-dock or 19-dock station	\$0.10 per sf (\$75K or \$49K minimum)
	Retail	1 per 5,000 sf	1 per 3,000 sf	1 per 60,000 sf (1 minimum)	1 per 6,000 sf (1 minimum)	Space for a 15-dock or 19-dock station	\$0.37 per sf (\$75K or \$49K minimum)
	Institutional [¶]	1 per 2,500 sf	1 per 2,500 sf	1 per 20,000 sf (1 minimum)	1 per 2,000 sf (1 minimum)	Space for a 15-dock or 19-dock station	\$0.42 per sf (\$75K or \$49K minimum)
	Lodging (Hotels, motels, inns, hostels)	1 per 20,000 sf (6 minimum)	1 per 5,000 sf	1 per 20,000 sf (1 minimum)	1 per 2,000 sf (1 minimum)	Space for a 15-dock or 19-dock station	\$75K or \$49K minimum

* Each post-and-ring or U-rack provides 2 bike parking spaces.

† At least 25% of required spaces must be on-ground and secured with post-and-ring or inverted U racks. At least 5% of required spaces (no less than two) must be both on-ground and extra-wide. Each post-and-ring or inverted U rack provides 2 bike parking spaces. All other spaces may be secured via two-tier racks, which provide a variable number of spaces. For senior housing, all required spaces must be on-ground and secured with post-and-ring or inverted U racks, with at least 10% of required spaces must be extra-wide.

‡ May be substituted with free access to showers and lockers at an on-site health club or gym that can be accessed without going outside.

§ The 19-dock requirement applies to projects located in the Downtown, West End, North End, Beacon Hill, Leather District, Chinatown, Bay Village, South End, Back Bay, Fenway, Longwood Medical Area, and South Boston Waterfront neighborhoods. The 19-dock requirement also applies to projects for which the calculated bikeshare contribution exceeds \$75K. The 15-dock requirement applies to all other developments.

| The \$75K and \$49K minimum contributions apply to projects subject to BPDA's Article 80 Large Project Review. The \$75K minimum contribution applies to projects in the same neighborhoods and neighborhood expansion areas identified above.

¶ Includes academic, medical, and civic buildings. Rates for these institutional uses and all others uses not listed should be determined in consultation with BTDA.

3. RACK SELECTION

I. PERFORMANCE CRITERIA

All bike racks in the City of Boston must meet the performance criteria summarized in Table 2—whether they are designed for short-term or long-term use. Collectively, these criteria ensure that racks support bikes upright, allow users to lock their bikes securely, and are intuitive and accessible to use. In certain constrained situations, two-tier racks that do not meet criterion E may be approved.

TABLE 2: PERFORMANCE CRITERIA FOR RACK STYLES

CRITERIA	DETAILS
A Supports bike upright	The rack provides two points of contact with the frame—at least 6" apart horizontally. Alternatively, if a rack cradles a bike's wheel, it also supports the frame securely at one point or more. The rack's highest point of contact is at least 2'8" off the ground.
B Allows locking of frame and at least one wheel with a U-lock	A closed loop of the rack allows a single U-lock to capture one wheel and a closed section of the bike frame. The rack tube's cross section is no larger than 2"—allowing locking with smaller U-locks.
C Materials are durable and secure	The rack is made from durable and difficult to cut materials, such as steel or stainless steel. Rack finish is appropriate to the location.
D Use is intuitive	The rack is recognizable by first-time users and easily usable as intended without the need for written instructions.
E Accommodates a variety of bikes and attachments	The rack serves common bike styles, including cargo bikes and accessible bikes. The rack does not restrict the length, height, or width of bikes, attachments (such as baskets), or wheels.

FIGURE 3: U-LOCK CAPTURING WHEEL AND BIKE FRAME

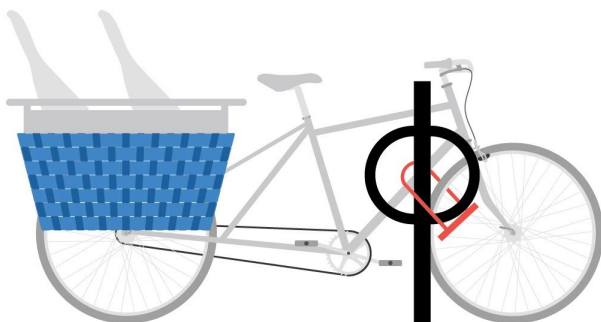

II. CITY OF BOSTON STANDARD RACK

The City of Boston’s standard rack is a **black, powder-coated post-and-ring rack** (also called hitch rack) with an **in-ground mounting mechanism**. Post-and-ring racks meet all of the City’s performance criteria. **They are the only racks approved for installation on city sidewalks, plazas, and other locations in the public right-of-way and are the only racks that can satisfy visitor parking guidelines.** They are appropriate for all other applications, as well. Each post-and-ring rack provides two bike parking spaces. They may be installed in a series to create parking areas of variable quantities.

TABLE 3: PERFORMANCE OF POST-AND-RING RACKS

CRITERIA	A	B	C	D	E
	Supports bike upright	Allows locking of frame and at least one wheel with a U-lock	Materials are durable and secure	Use is intuitive	Accommodates a variety of bikes and attachments
POST-AND-RING <i>also called a hitch</i>		Y	Y	Y	Y

FIGURE 4: SPECIFICATIONS FOR THE CITY OF BOSTON STANDARD RACK



III. INVERTED U RACKS

When properly designed and installed, inverted U racks meet all of the City’s performance criteria. You may install inverted U racks for employee/resident bike parking. Each inverted U rack creates two bike parking spaces. They may be installed in a series to create parking areas of variable quantities.

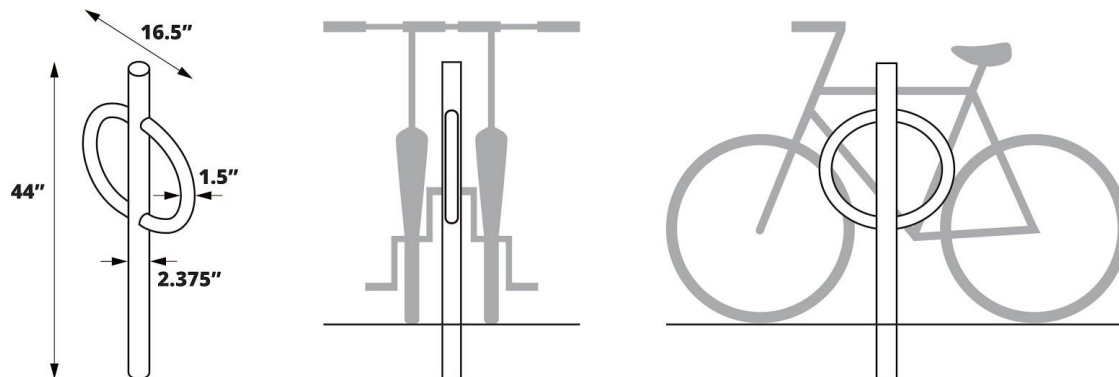
IV. TWO-TIER RACKS

You may also install two-tiered racks for employee/resident bike parking. Two-tier racks maximize the use of limited parking space by stacking a second row of bikes above the first. **A lift assist is required for the upper tier of parking**, as bikes can be heavy and challenging to maneuver overhead. Even with lift assists, two-tier racks do not work for all bike users and fail to accommodate common bike styles and attachments. For this reason, you must accompany two-tier racks with on-ground spaces secured by post-and-ring or inverted U racks.

Two-tier racks require maintenance for moving parts, and their design and performance varies by manufacturer. BTD must pre-approve all two-tier racks as satisfying the City’s performance criteria².

BTD will consider other high density racks, such as vertical racks, only for the retrofit of existing buildings—and on a case-by-case basis.

FIGURE 5: TWO-TIER RACKS

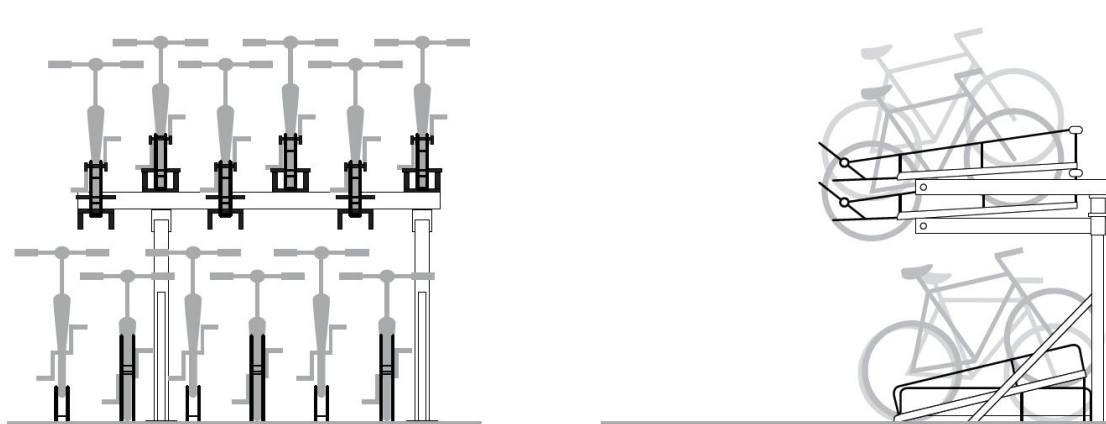

² This applies to installations in projects subject to Transportation Access Plan Agreements and Site Plan Review administered by BTD, as well as all projects subject to BPDA’s Article 80 Small and Large Project review process.

TABLE 4: PERFORMANCE OF INVERTED U AND TWO-TIER RACKS

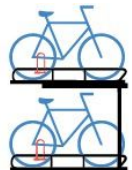





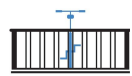

CRITERIA		A	B	C	D	E
		Supports bike upright	Allows locking of frame and at least one wheel with a U-lock	Materials are durable and secure	Use is intuitive	Accommodates a variety of bikes and attachments
INVERTED U <i>also called staple, loop, arc</i>		Y	Y	Y	Y	Y
TWO-TIER		Y	Y	Y	Y	N

V. PROHIBITED RACKS

Do not install the following rack styles. They do not satisfy the City’s performance criteria and are never acceptable for installation. All other racks, including custom racks, must be pre-approved by BTM as satisfying the City’s performance criteria.

TABLE 5: PERFORMANCE OF PROHIBITED RACKS

CRITERIA		A	B	C	D	E
		Supports bike upright	Allows locking of frame and at least one wheel with a U-lock	Materials are durable and secure	Use is intuitive	Accommodates a variety of bikes and attachments
WAVE <i>also called undulating, serpentine</i>			Y	Y	N	N
SCHOOLYARD <i>also called comb, grid</i>			N	N	N	N

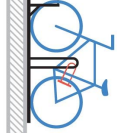
CRITERIA		A	B	C	D	E
		Supports bike upright	Allows locking of frame and at least one wheel with a U-lock	Materials are durable and secure	Use is intuitive	Accommodates a variety of bikes and attachments
COATHANGER		Y	Y	Y	Y	N
WHEELWELL		N	N	N	Y	N
WHEELWELL-SECURE		N	Y	Y	Y	N
SPAR		N	N	Y	N	N
BOLLARD		N	Y	Y	Y	N
MONOLITH		N	Y	N	N	N
SPIRAL		N	Y	Y	N	N
SWING ARM SECURED		Y	Y	Y	N	N
VERTICAL		N	Y	Y	N	N

4. VISITOR PARKING

Visitor parking meets the needs of people visiting businesses, institutions, residences, and other destinations for **shorter periods of time**—generally no more than a few hours. Because users may be infrequent visitors to a location, parking must be **visible from the public right-of-way, conveniently located, legible as parking, and intuitive to use.**

I. LOCATION

Choose locations that are **visible and accessible** from the public right-of-way and **close to major building entrances**—ideally less than 25’ away and never more than 50’. Ensure that the area is **well-lit** during both daytime and nighttime hours. Areas with a high incidence of bike theft may justify specific security measures such as active surveillance. Though not required, we encourage siting visitor parking in sheltered locations wherever possible. This facilitates year-round use, even during inclement weather.

I. RACK TYPE

The City of Boston’s standard post-and-ring rack is the only rack approved for satisfying visitor parking guidelines and for installation in the public right-of-way.

II. CLEARANCES

Racks installed on sidewalks, plazas, and other locations in the public right-of-way must **preserve accessibility** for people walking and using assistive mobility devices. You must leave at least 5’ clearance along sidewalks and other lines of travel. When installing more than 4 racks, cluster them in groups of 3 or 4 to allow people to pass between clusters. Additionally, use the following table to site racks at appropriate distances from other objects.

TABLE 6: CLEARANCES FROM RACKS TO OBJECTS

OBJECT	DISTANCE³
Curb ramps, fire hydrants	6’ recommended (5’ minimum)
Bus stops, bus shelters, commercial loading zones	5’ recommended (4’ minimum)
Accessible parking (HP-V) spaces, driveways (as measured from the face of the curb), and all other street furniture not already noted (e.g. light poles, sign posts, trash cans, edges of tree pits, mailboxes)	4’ recommended (3’ minimum)

³Measure from the center of the rack to the edge of the object.

Along narrow sidewalks, install racks parallel to the curb to maintain an accessible pedestrian path of travel. (Users park their bikes in the same orientation as the rack.) Along wider sidewalks and in plazas, you may install racks perpendicular to the curb or angled at 45 degrees, in consultation with BTB. The images below provide minimum sidewalk widths required for each orientation. Finally, try to position racks between vehicle parking spaces to avoid conflicts with car doors.

FIGURE 6: SIDEWALK CLEARANCES FOR 3 RACK ORIENTATIONS

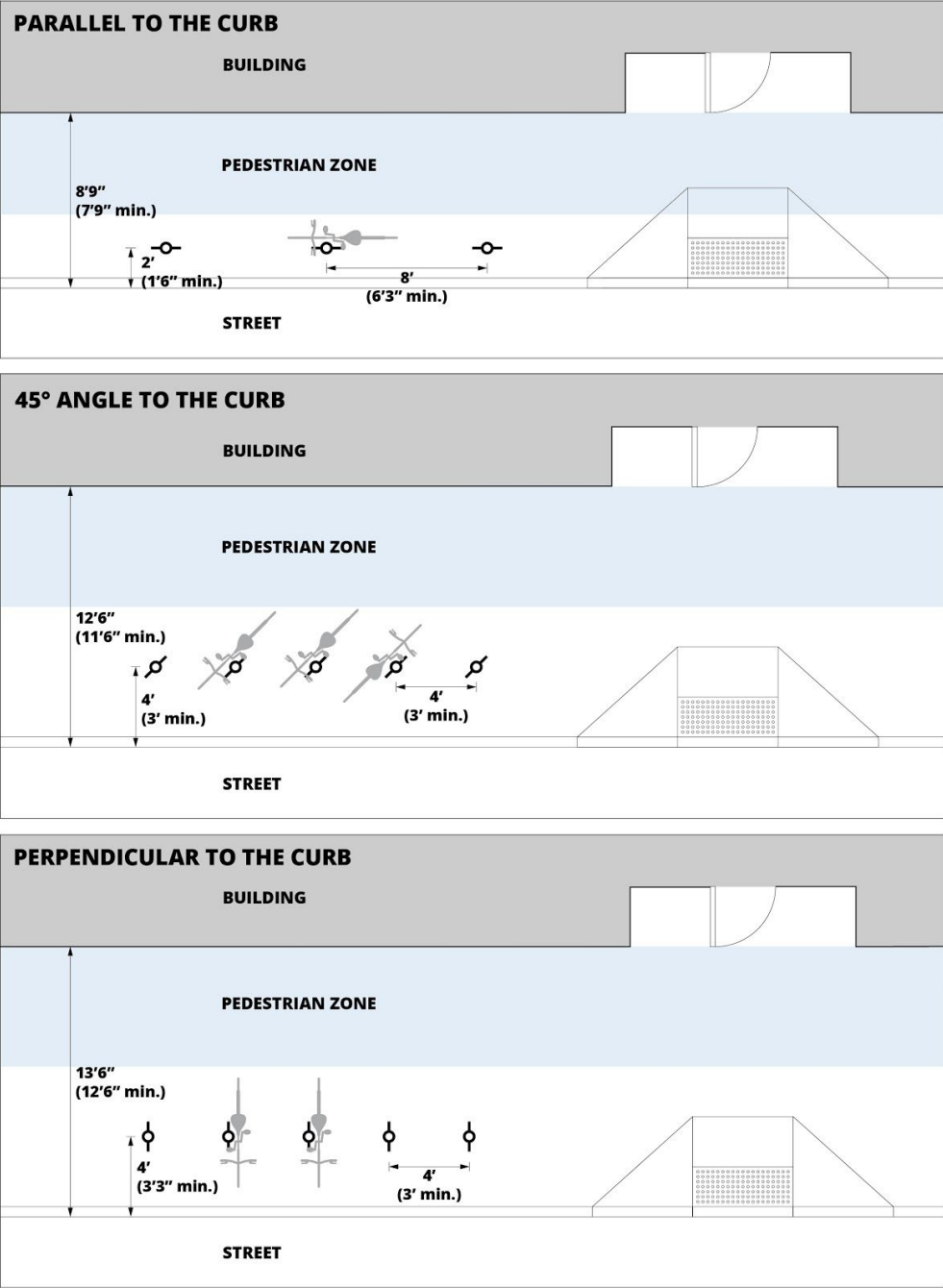

5. EMPLOYEE/RESIDENT PARKING

Employee/resident bike parking meets the needs of people looking to store their bikes for **longer periods of time** at their workplace, school, or residence. Because long-term users leave their bikes unmonitored for a period of several hours or longer, their parking must be in a **secure and weather-protected location**⁴. Bike parking rooms should be **clean, well-lit, easy to move within, and easily accessible from the street**.

I. LOCATION AND ACCESS

Bike parking should be **as convenient—or more convenient—than car parking**. Whenever possible, locate employee/resident bike parking **inside the same building** as the people it is intended to serve (e.g. in each building of a multi-building development) and **immediately adjacent to and at-grade** with the public right-of-way. If necessary, you may also site bike parking within 100' of a primary entrance, as measured by walking distance, and, preferably, no more than one level above or below grade. At least one route from the public right-of-way to the employee/resident bike parking must meet the following performance criteria⁵.

TABLE 7: PERFORMANCE CRITERIA FOR ACCESS ROUTES

CRITERIA	DETAILS
A Route is free of obstructions	Route is easily navigated with common bikes and bike accessories. Impermissible obstructions include objects, motor vehicle spaces, and loading areas.
B Route is at least 5' wide, with no more than two doors or other constriction points	Constriction points are no narrower than 3' wide and extend no more than 1' of distance.
C Doorways along the route are accessible and self-opening	Doors are manufactured to meet accessibility requirements and guidelines. They are self-opening, either automatically or triggered by a button or key fob.
D Route has no stairs, steep ramps, or small elevators	Changes in grade require either a ramp or an elevator. Ramps have a slope less than 5%. Elevators are at least 6'8" long and 4'6" wide.
E Route is well-lit	The route must be well-lit and include, as appropriate, motion-activated lighting.

⁴ "Essentials of Bike Parking." Association of Pedestrian and bike Professionals. Revision 1.0, September 2015. Nathan Broom, lead author.

⁵ Employee/resident bike parking may also be accessible secondarily by routes that do not meet these exact requirements, such as parking garage entrance ramps.

In certain constrained situations, you may provide employee/resident bike parking in a bike shed, bike lockers, a car parking garage, or another enclosed structure within 100' of a main pedestrian entrance to the building that the bike parking is intended to serve, as measured by walking distance. BTD must pre-approve such installations as properly located and adequately secure and protected. Bike parking in a car parking garage must be at grade or on the first level of car parking and both the bike parking and the primary access route must be physically separated from vehicles. Where there is a shared secondary access route, it must be delineated to safely accommodate people biking.

II. RACK TYPES

Use post-and-ring and inverted U racks to provide as many employee/resident bike parking spaces as possible. In constrained situations, it may be appropriate to include two-tier racks **with lift assists** for the upper tier of racks. Two-tier racks should not be used in senior housing.

To avoid excluding people because of age, ability, or bicycle type, it's important to **accompany two-tier racks with on-ground spaces** secured by post-and-ring or inverted U racks, especially to encourage biking among older adults and people with mobility disabilities. A portion of these on-ground spaces should be **extra-large** to accommodate wider and longer bikes and trailers. Clearly demarcate these spaces with text reading "big bikes only" on both the rack and the pavement. Figure 7 describes our baseline proportions for extra-large spaces, on-ground spaces, and two-tier spaces.

BTD must pre-approve all installations of employee/resident bike parking to ensure compliance with our performance criteria.

FIGURE 7: BASELINE PROPORTIONS FOR EMPLOYEE/RESIDENT BIKE PARKING

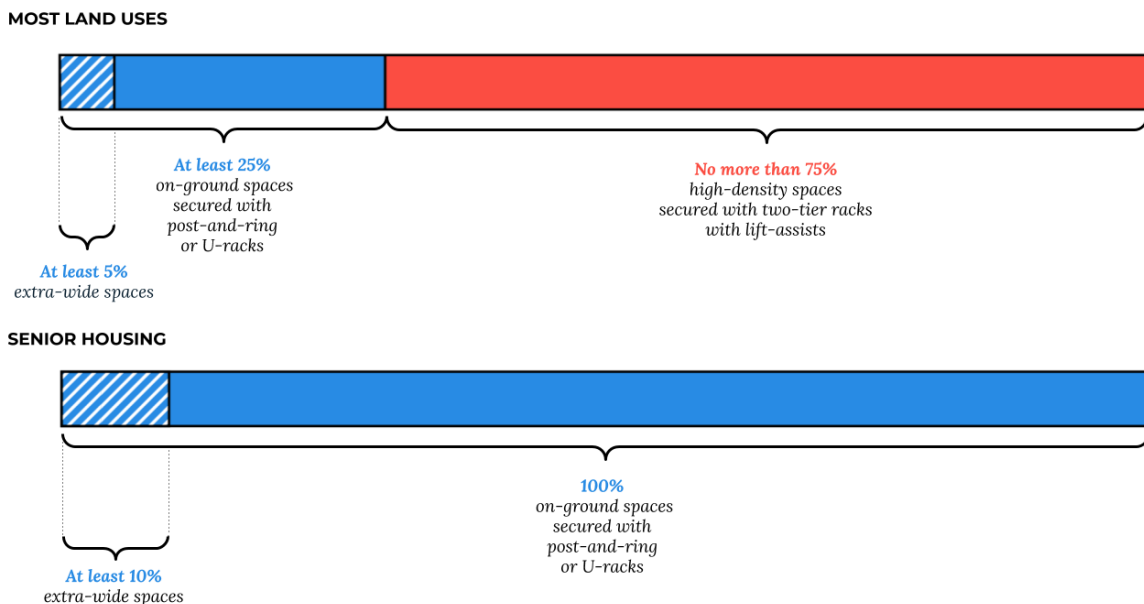

III. CLEARANCES

Design employee/resident bike parking to **allow comfortable maneuvering** of all common bike styles and attachments. For example, users should never have to move other people’s bikes to access their own spaces. Aisles must be at least 6’ wide and racks must be offset an adequate distance from walls, other fixed objects, and from each other. Figures 8 and 9 describe the clearances we require within example bike parking rooms.

FIGURE 8: MINIMUM CLEARANCES IN A SMALL BIKE PARKING ROOM

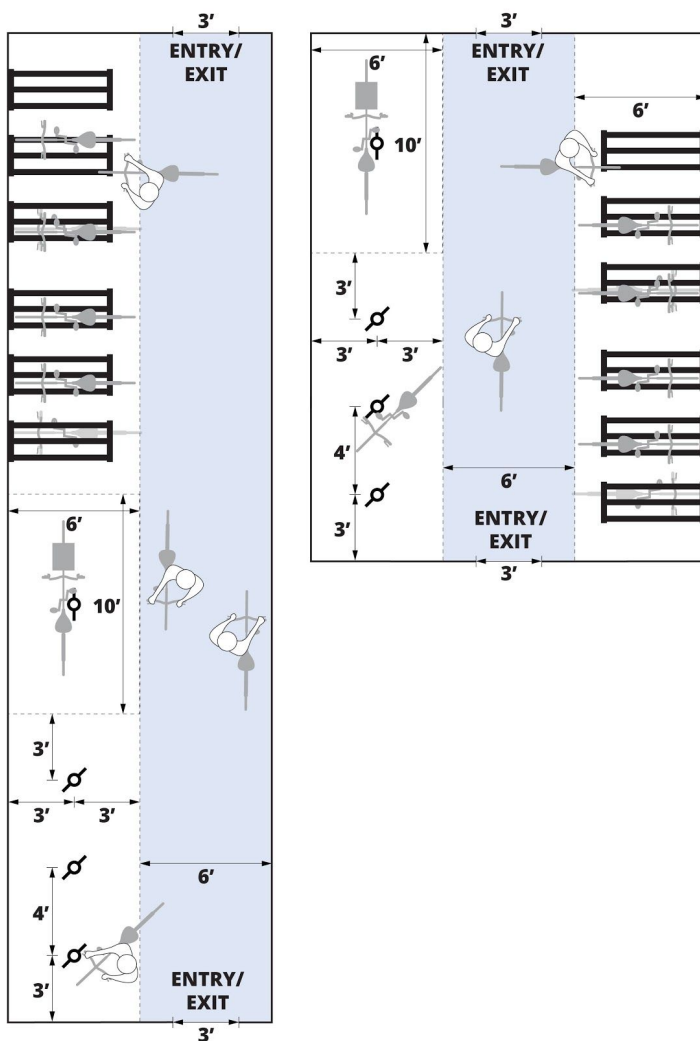

WHAT'S DEPICTED

These are two example configurations of an employee/resident bike parking room that satisfies quantities for a 30-unit residence with a 1,500 sf retail space.

ACCOMMODATIONS

Extra-wide spaces*

Minimum: 2
Depicted: 2

On-ground spaces†

Minimum: 8
Depicted: 8

Two-tier spaces with lift assists‡

Minimum: N/A
Depicted: 24

Compliant access route

Minimum: 1
Depicted: 1

* At least 5% of spaces (no less than two) must be extra-wide. These spaces must be on the ground and secured with post-and-ring or U-racks. As such, they also count towards the inventory of on-ground spaces.

† At least 25% of spaces must be on the ground and secured with post-and-ring or U-racks (each post-and-ring or U-rack serves 2 bike parking spaces).

‡ Follow manufacturers' instructions for clearances around and above two-tier racks.

FIGURE 9: MINIMUM CLEARANCES IN A LARGE BIKE PARKING ROOM

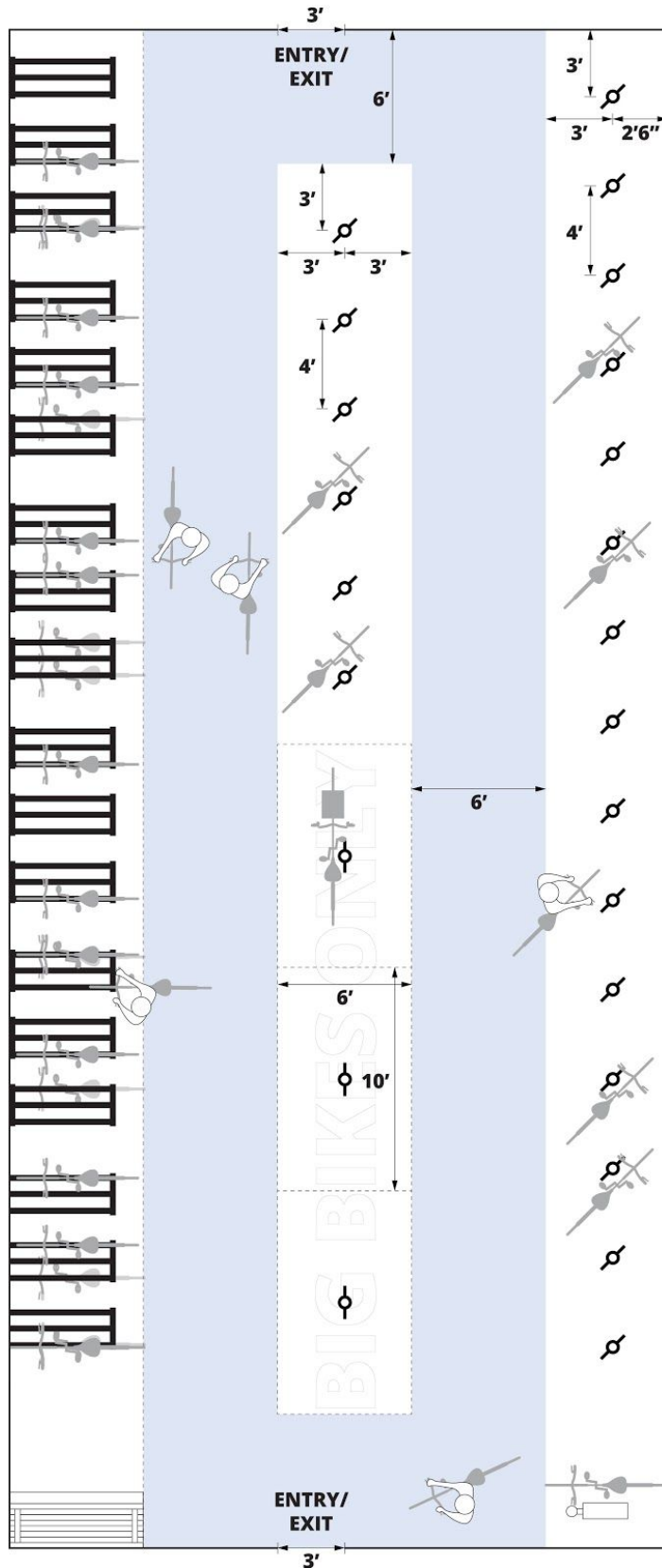

WHAT'S DEPICTED

This is an example of an employee/resident bike parking room that satisfies quantities for any of the following developments. (Note: Showers and changing facilities are required for non-residential uses).

- ▶ 120-unit residence
- ▶ 240-bed dorm
- ▶ 300,000 sf office building
- ▶ 1,440,000 sf industrial site
- ▶ 360,000 sf retail center
- ▶ 600,000 sf hotel

ACCOMMODATIONS

Extra-wide spaces⁺

Minimum: 6
 Depicted: 6

On-ground spaces[†]

Minimum: 30
 Depicted: 48

Two-tier spaces with lift assists[‡]

Minimum: N/A
 Depicted: 72

Compliant access route

Minimum: 1
 Depicted: 2

OPTIONAL AMENITIES

- ▶ Fix-it station and pump
- ▶ Bench

* At least 5% of spaces (no less than two) must be extra-wide. These spaces must be on the ground and secured with post-and-ring or U-racks. As such, they also count towards the inventory of on-ground spaces.

† At least 25% of spaces must be on the ground and secured with post-and-ring or U-racks (each post-and-ring or U-rack serves 2 bike parking spaces).

‡ Follow manufacturers' instructions for clearances around and above two-tier racks.

IV. SECURITY

Provide employee/resident bike parking behind **locked doors**, with access limited to authorized users (e.g. building employees, residents, and other regular occupants). Options for access control include keys, fobs, and smart cards. Install **motion-activated security lights in tamper-proof cases** and, whenever possible, ensure that the entire area is **visible from the entry door** and **video surveillance cameras**.

V. SIGNAGE

Where employee/resident bike parking is not visible from the public right-of-way, **install directional signage**. Such signage must be visible from all adjacent on-street bike facilities. In building directories, describe the location of bike parking wherever you describe the location of car parking.

VI. PRICING

All employee/resident bike parking should be provided **at no cost** to building employees, residents, and other regular building occupants.

VII. ELECTRIC BIKE CHARGING

Electric bikes make cycling a possibility for more people, especially older adults. To accommodate electric bikes with charging cords, install standard 120V electric outlets within 4' of the center of bike parking spaces. Electric bike parking helps fulfill Boston's Electric Vehicle Readiness Policy for New Developments⁶ and should be given extra consideration in senior housing.

6. SHOWERS AND CHANGING FACILITIES

Showers and changing facilities allow employees, residents, and other regular building occupants to **bike year-round** without sacrificing personal hygiene. Ensure that these facilities are **conveniently located** for people using the employee/resident bike parking areas and that they **follow all accessibility requirements** in the State Building Code (521 CMR).

⁶ Electric Vehicle Readiness Policy for New Developments. Accessed December 4, 2019. www.boston.gov/recharge-boston

7. BIKESHARE

Bikeshare stations connect people to Boston’s fastest-growing form of public transportation. Bikeshare makes biking accessible to more people by offering **affordably priced, one-time trips and memberships**—without the need to own or maintain a bicycle. Bikeshare is also a convenient option for people who wish to take one-way bike trips or combine biking with other travel modes like the MBTA.

I. STATION CONFIGURATIONS

The City of Boston’s standard bikeshare station has at least **19 docks**, a kiosk for rental transactions, a solar panel, and a map panel. It measures, at a minimum, 52’ by 6’ and requires 8’ of vertical clearance, as illustrated in Figure 10. There are a few additional configurations that can be helpful in constrained situations, which are illustrated in Figure 11. The exact station size must be determined with BTD during the Article 80 process and finalized during the TAPA process. In certain circumstances, BTD may accept other forms of bikeshare system infrastructure or equipment in lieu of space for a station.

II. LOCATION AND ACCESS

Bikeshare users may be infrequent visitors to a location. For this reason, it’s important that stations are **conveniently located off-street**, often in the public right-of-way. If located on private property, they must be **visible** from the public right-of-way. They should have **good night-time lighting** and, for solar charging, a few hours of **direct sunlight** every day. They also need to be **publicly accessible** at all times and relatively **easy to service** for bike rebalancing and general maintenance (bikeshare operation crews usually come by van or bike and need to stop nearby). Stations plates cannot cover utility access points such as sewer grates and manholes.

BTD must approve the selected location and reserves the right to place development-funded stations at a distance from the project to ensure the viability of the bikeshare network.

III. CLEARANCES

Stations must preserve at least 6’ clearance for pedestrians in the public right-of-way. In busier areas, 7’ is more appropriate. (This pedestrian clearance cannot include tree pits or other landscaping.) Use Table 8 and Figures 10 and 11 to site stations at appropriate distances from buildings, curbs, and other objects in the public right-of-way.

TABLE 8: CLEARANCES FROM STATIONS TO OBJECTS

OBJECTS	CLEARANCE ⁷
Fire hydrants	5' recommended 3' minimum
Curb ramps	4' recommended 3' minimum
Accessible parking (HP-V) spaces, driveways	3' recommended 2' minimum

FIGURE 10: STATION CLEARANCES ON A SIDEWALK

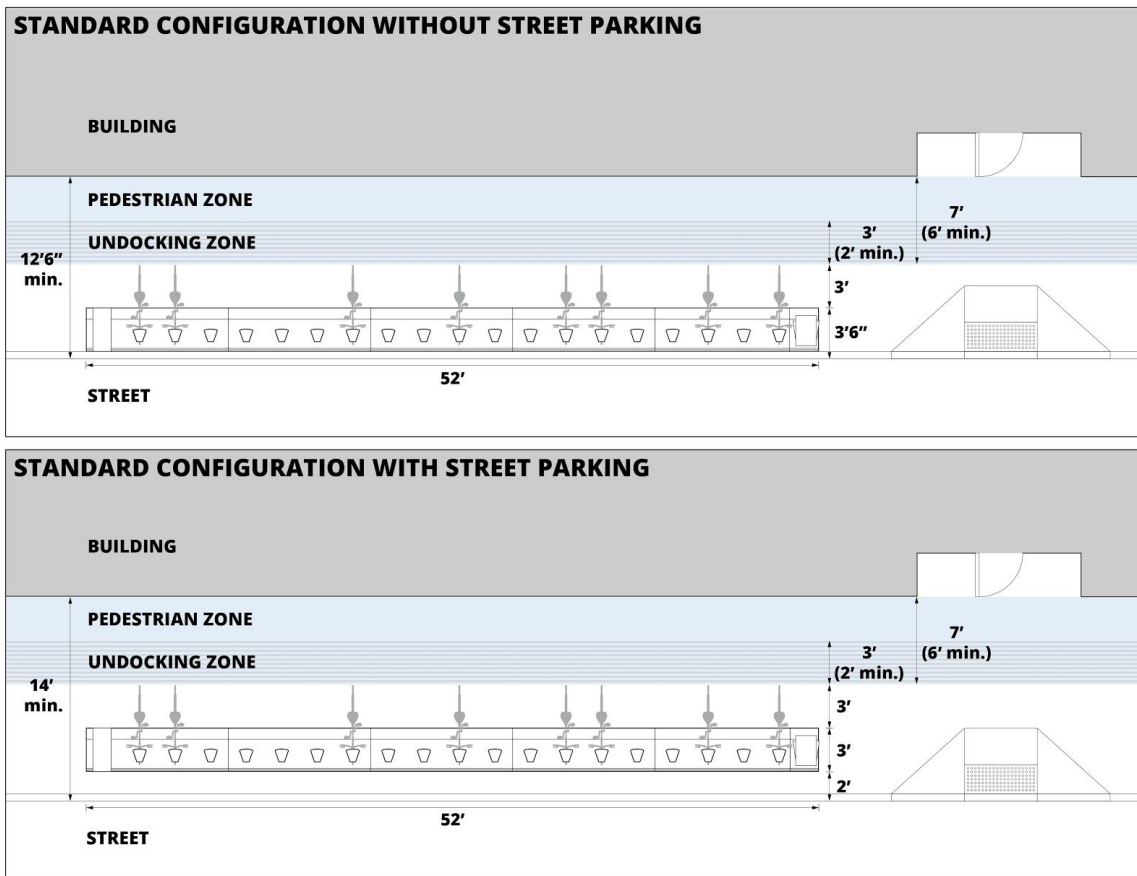

⁷Measure from the edge of the station to the edge of the object.

FIGURE 11: COMMON STATION CONFIGURATIONS

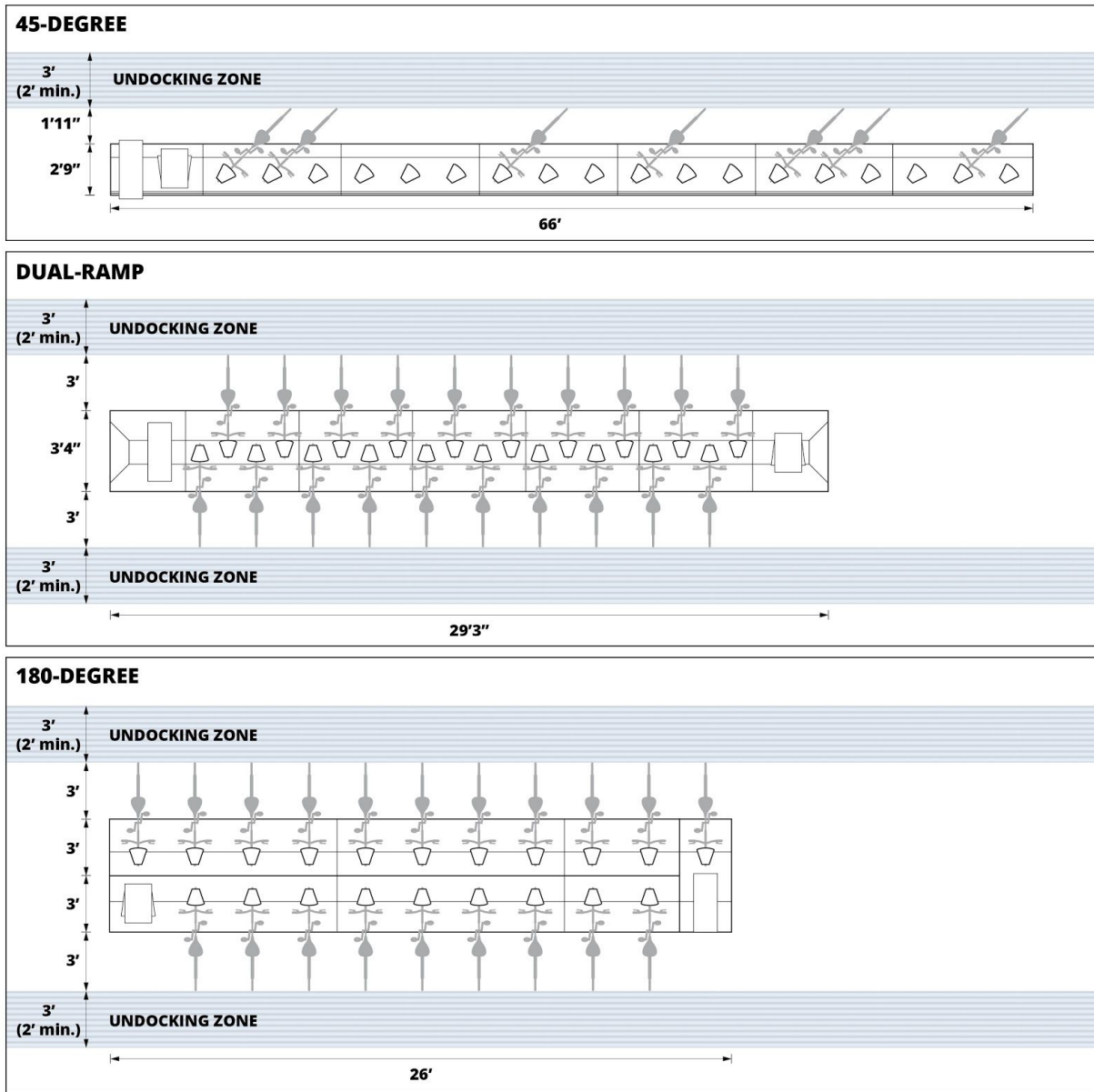

8. APPENDIX: INSTALLING RACKS

Install racks in-ground into an appropriate base material such as concrete, brick, or permeable pavers. Never install racks in organic matter such as grass, dirt, or mulch—or in asphalt. Follow manufacturers’ instructions and the minimum standards in Figures 12, 13, and 14. Failure to do so may render racks unusable.

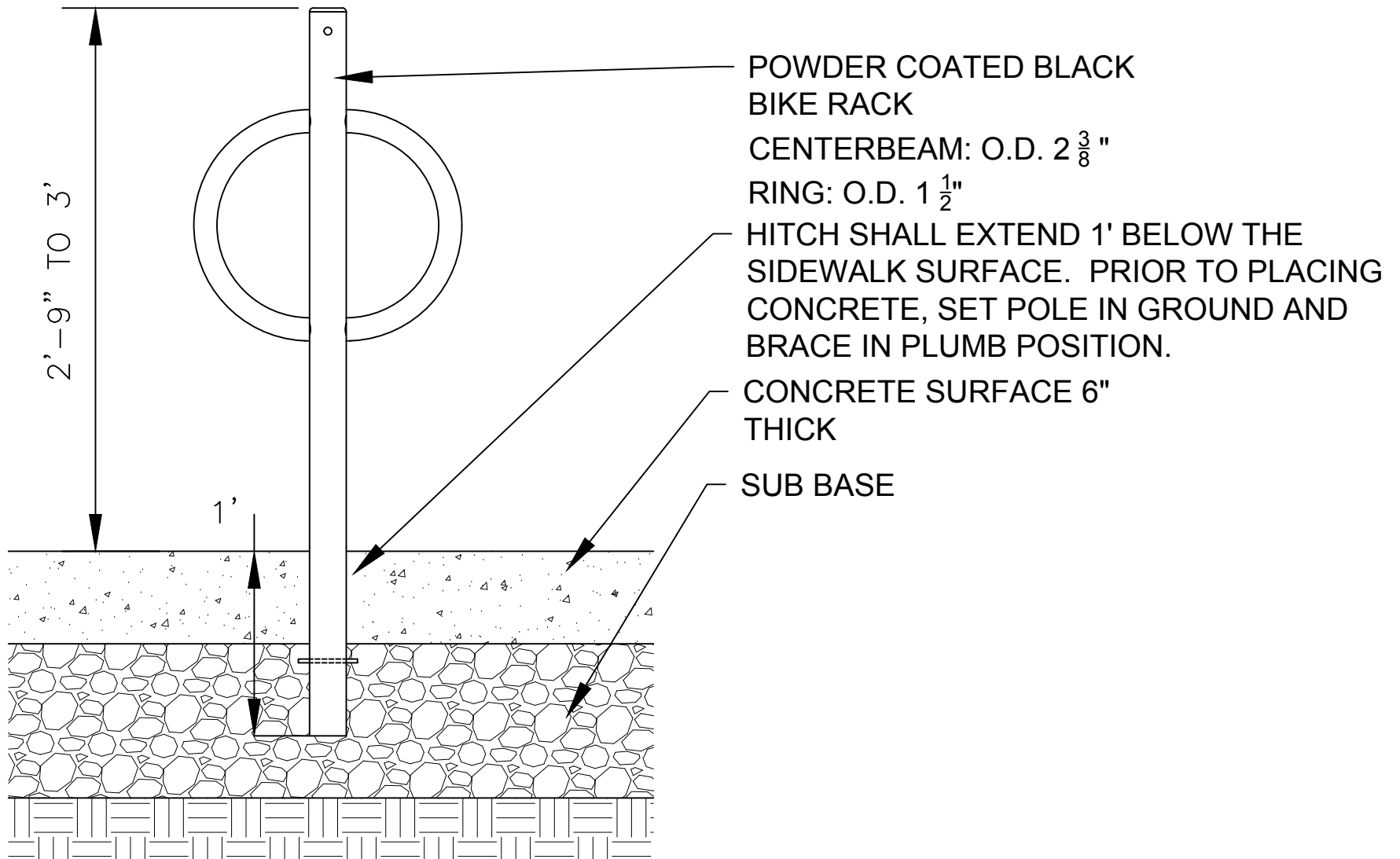

NEW CONCRETE SIDEWALK
IN GROUND MOUNT

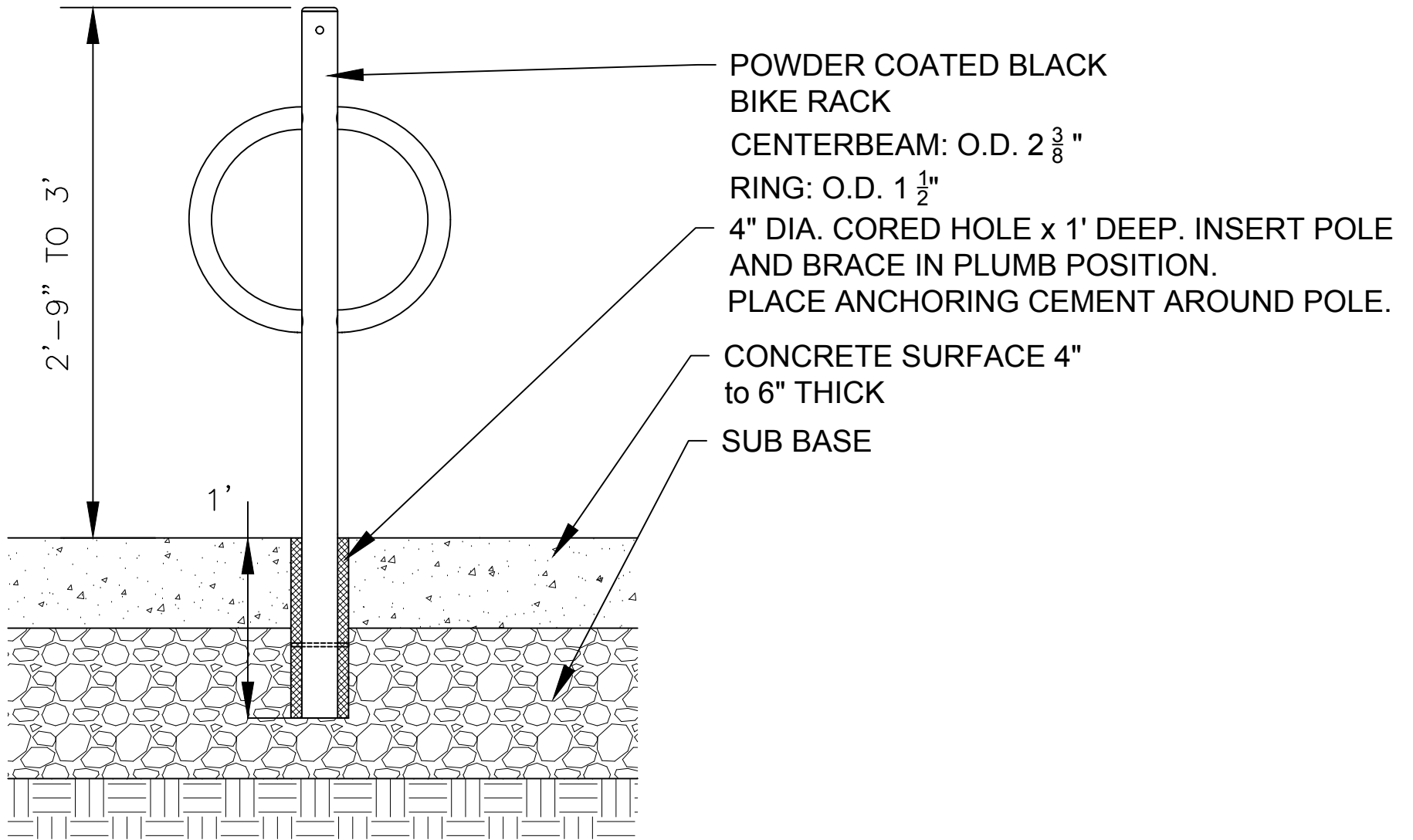

EXISTING CONCRETE SIDEWALK
IN GROUND MOUNT

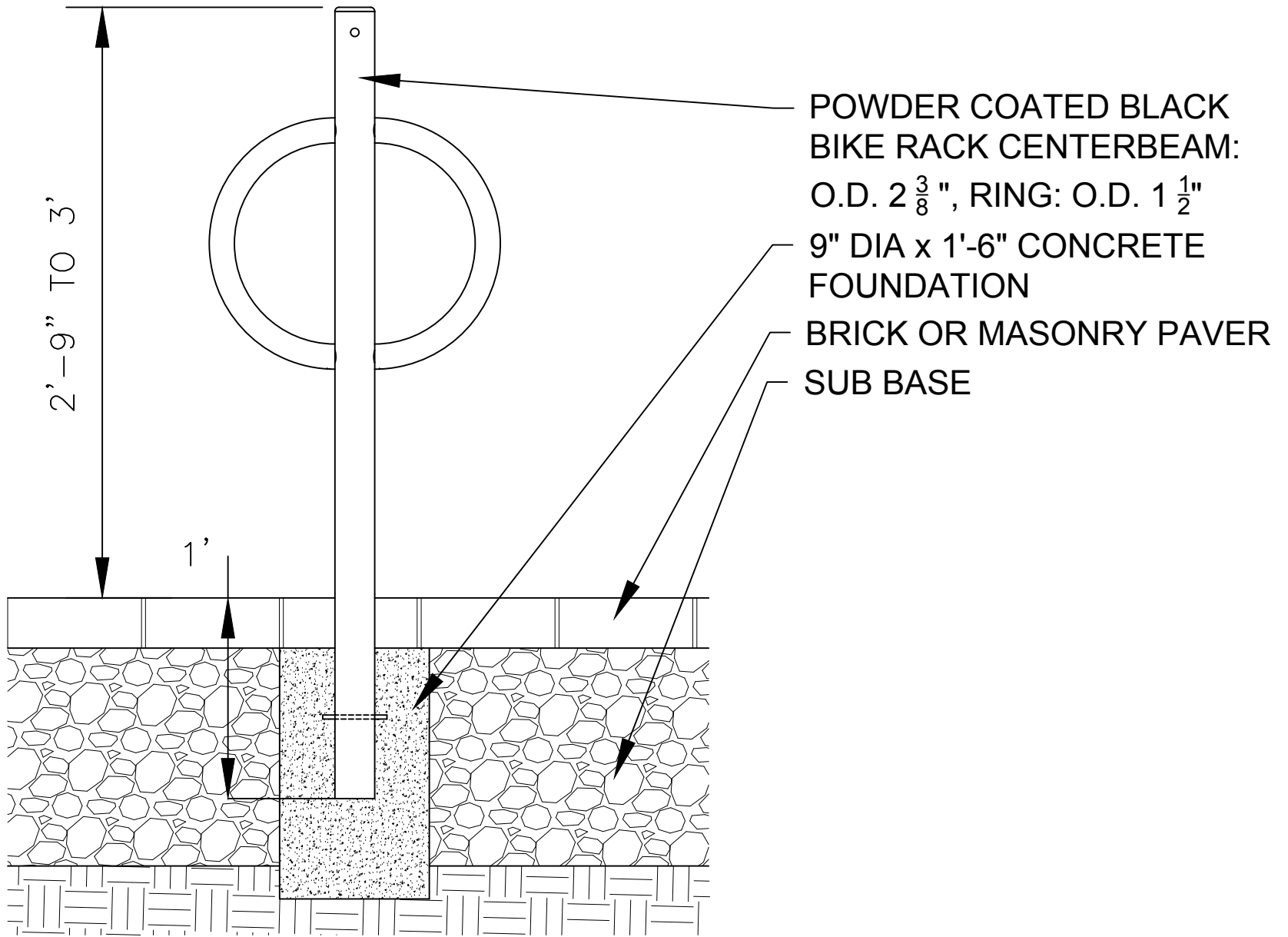

BRICK OR MASONRY PAVER SURFACE