



339 Marlborough Street Existing Front



339 Marlborough Street Front Yard & Stoop



339 Marlborough Street Entry Door



339 Marlborough Street Front Yard



339 Marlborough Street Front Yard Area Well



339 Marlborough Street Rear



339 Marlborough Street Rear Garden



339 Marlborough Street Rear Garden



339 Marlborough Street Rear Garden Fence



339 Marlborough Street Parking Area



339 Marlborough Street Roof Northwest



339 Marlborough Roof Northeast



339 Marlborough Roof Southeast



339 Marlborough Roof Southwest

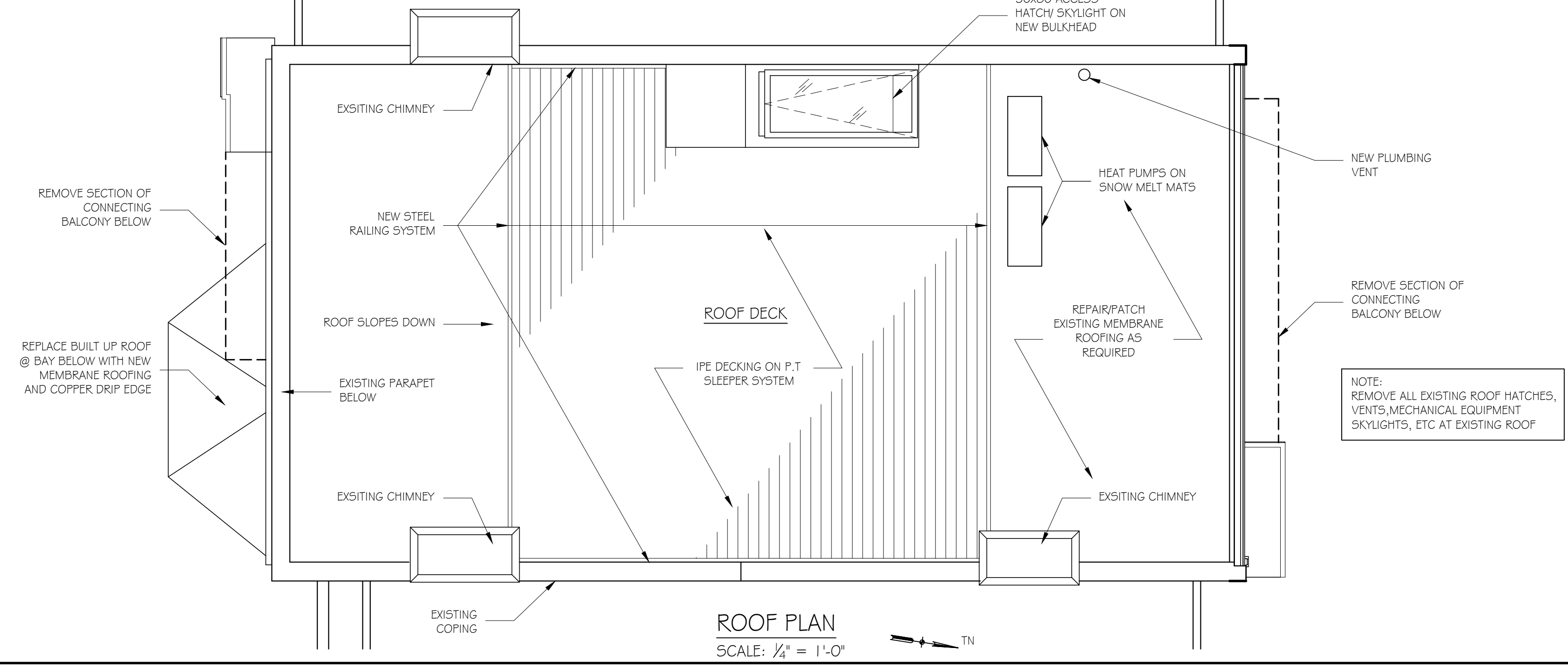
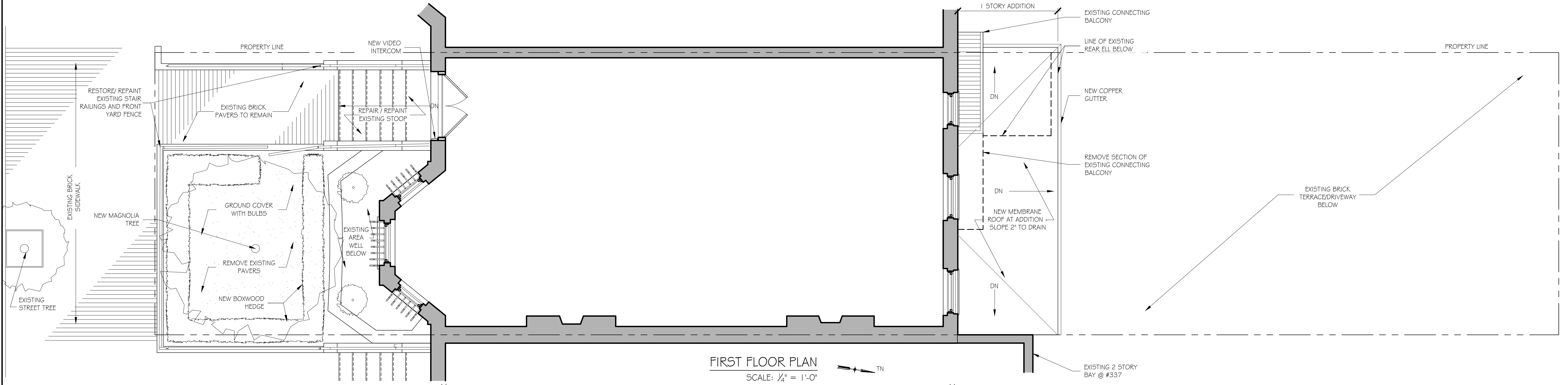
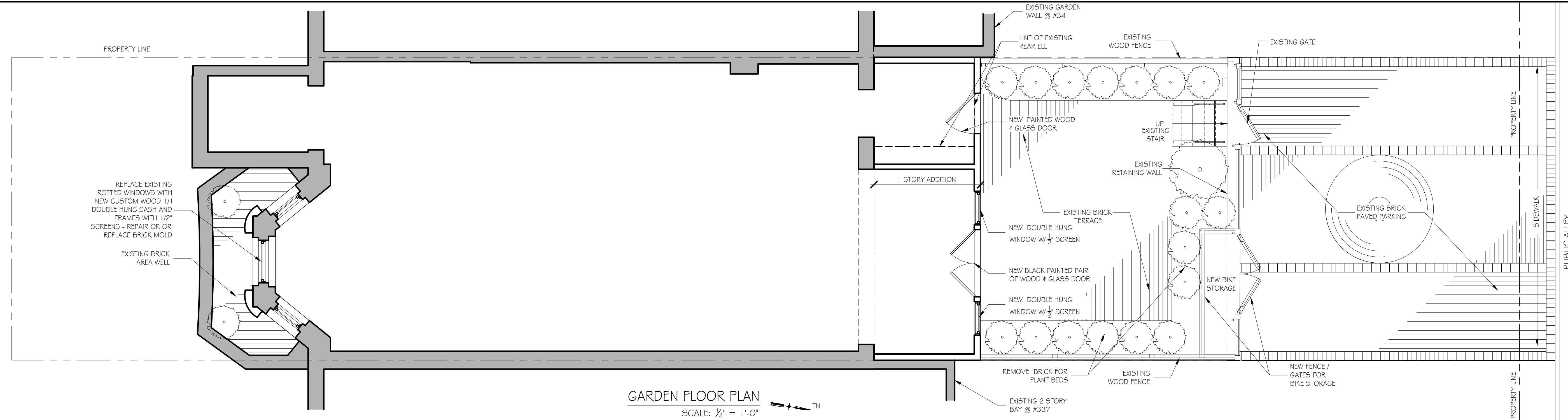

45 Newbury Street, Suite 506
Boston, MA 02116
Phone 617.956.9992
Fax 917.956.9993

GD GRASSI DESIGN GROUP
BG BEAUCHEMIN GRASSI INTERIORS

JOB NO: 2322
SCALE: 1/4" = 1'-0"
DATE: 12.12.23
REVISED

339 MARLBOROUGH STREET
BOSTON, MA

GARDEN, FIRST FLOOR AND ROOF PLAN

1

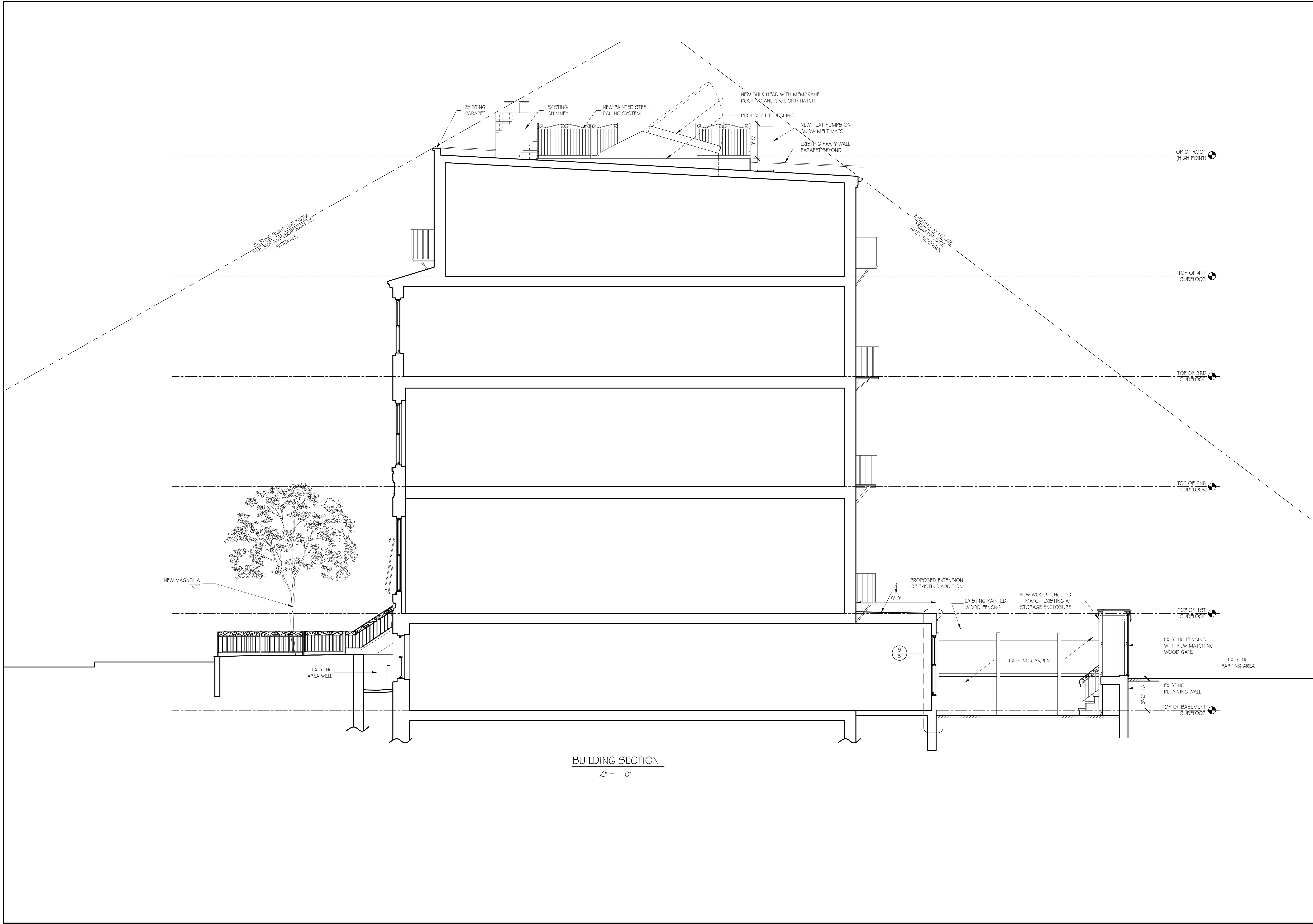

BUILDING SECTION
 $\frac{1}{4}" = 1'-0"$



SOUTH ELEVATION
 $\frac{1}{4}'' = 1'-0''$

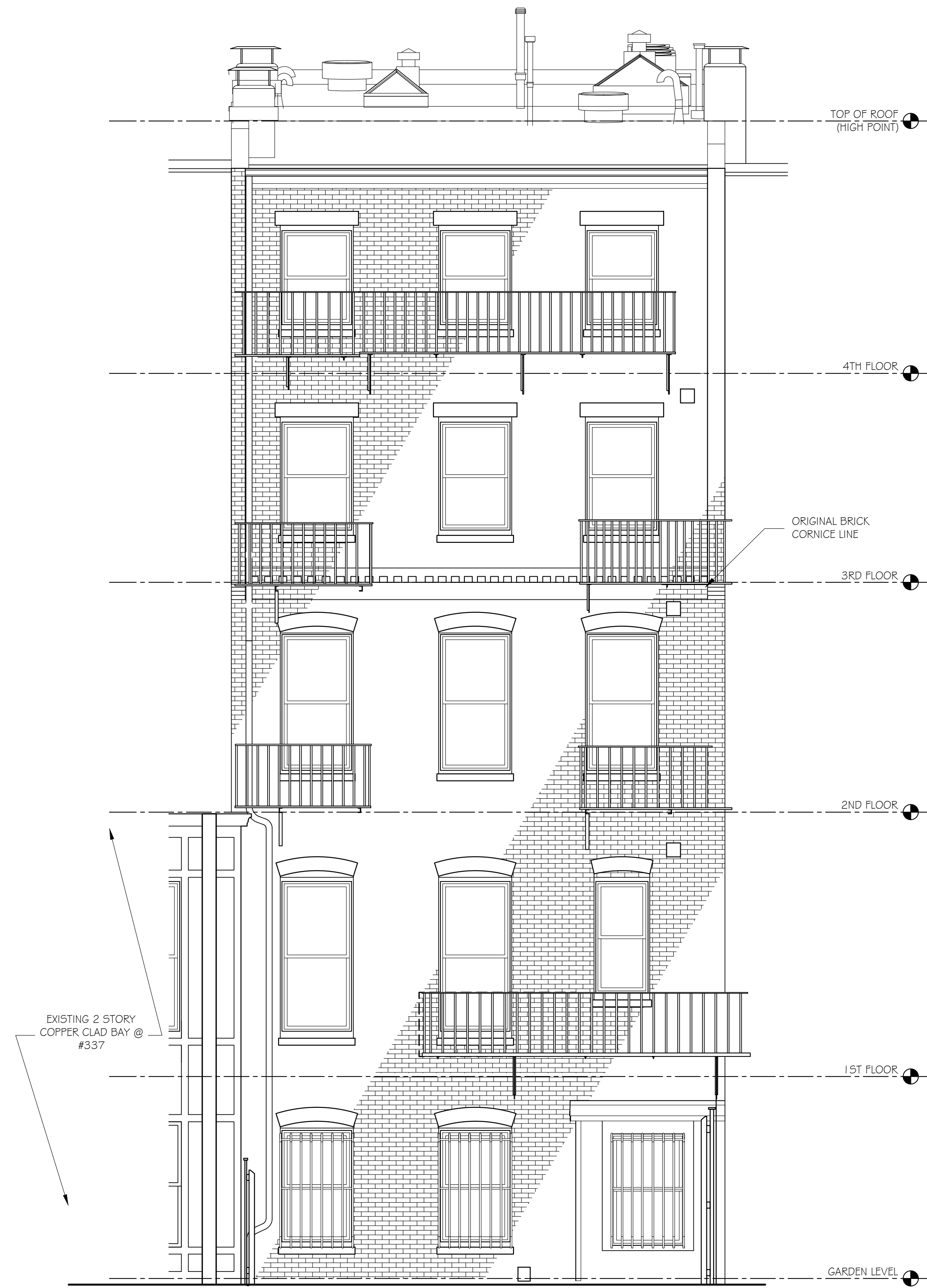

NORTH ELEVATION
 $\frac{1}{4}'' = 1'-0''$

JOB NO: 2322	
SCALE: $\frac{1}{4}'' = 1'-0''$	
DATE: 12.15.23	
REVISED	

339 MARLBOROUGH STREET
 BOSTON, MA

EXISTING NORTH & SOUTH
 ELEVATIONS



SOUTH ELEVATION
 $\frac{1}{4}'' = 1'-0''$

NORTH ELEVATION AT GARDEN - OPTION 1
 $\frac{1}{4}'' = 1'-0''$

NORTH ELEVATION AT GARDEN - OPTION 2
 $\frac{1}{4}'' = 1'-0''$



FENCE ELEVATION AT PARKING AREA
 $\frac{1}{4}'' = 1'-0''$

45 Newbury Street, Suite 506
 Boston, MA 02116
 Phone 617.956.9992
 Fax 917.956.9993

GD GRASSI DESIGN GROUP
BG BEAUCHEMIN GRASSI INTERIORS

JOB NO: 2322
 SCALE: $\frac{1}{4}'' = 1'-0''$
 DATE: 12.12.23
 REVISED

339 MARLBOROUGH STREET
 BOSTON, MA

NORTH & SOUTH ELEVATIONS

EXTERIOR DETAILS

<p>1 TYP. WINDOW HEAD DTL. IN MASONRY OPENING (JAMB SIM.) 1 1/2" = 1'-0"</p>	<p>2 RAILING DETAIL @ ROOF DECK 1 1/2" = 1'-0"</p>	<p>3 NOT USED</p>	<p>4 ROOF ACCESS HATCH DETAIL @ PARTY WALL 1 1/2" = 1'-0"</p>	<p>9 WALL SECTION @ ADDITION 1 1/2" = 1'-0"</p>
<p>5 TYP. WINDOW SILL DETAIL IN MASONRY OPENING 1 1/2" = 1'-0"</p>	<p>6 NOT USED</p>	<p>7 ROOF ACCESS HATCH DETAIL @ DECK 1 1/2" = 1'-0"</p>	<p>8 ROOF ACCESS HATCH DETAIL 1 1/2" = 1'-0"</p>	<p>9 WALL SECTION @ ADDITION 1 1/2" = 1'-0"</p>

DOOR & WINDOW TYPE ELEVATIONS - SCALE: 1" = 1'-0"

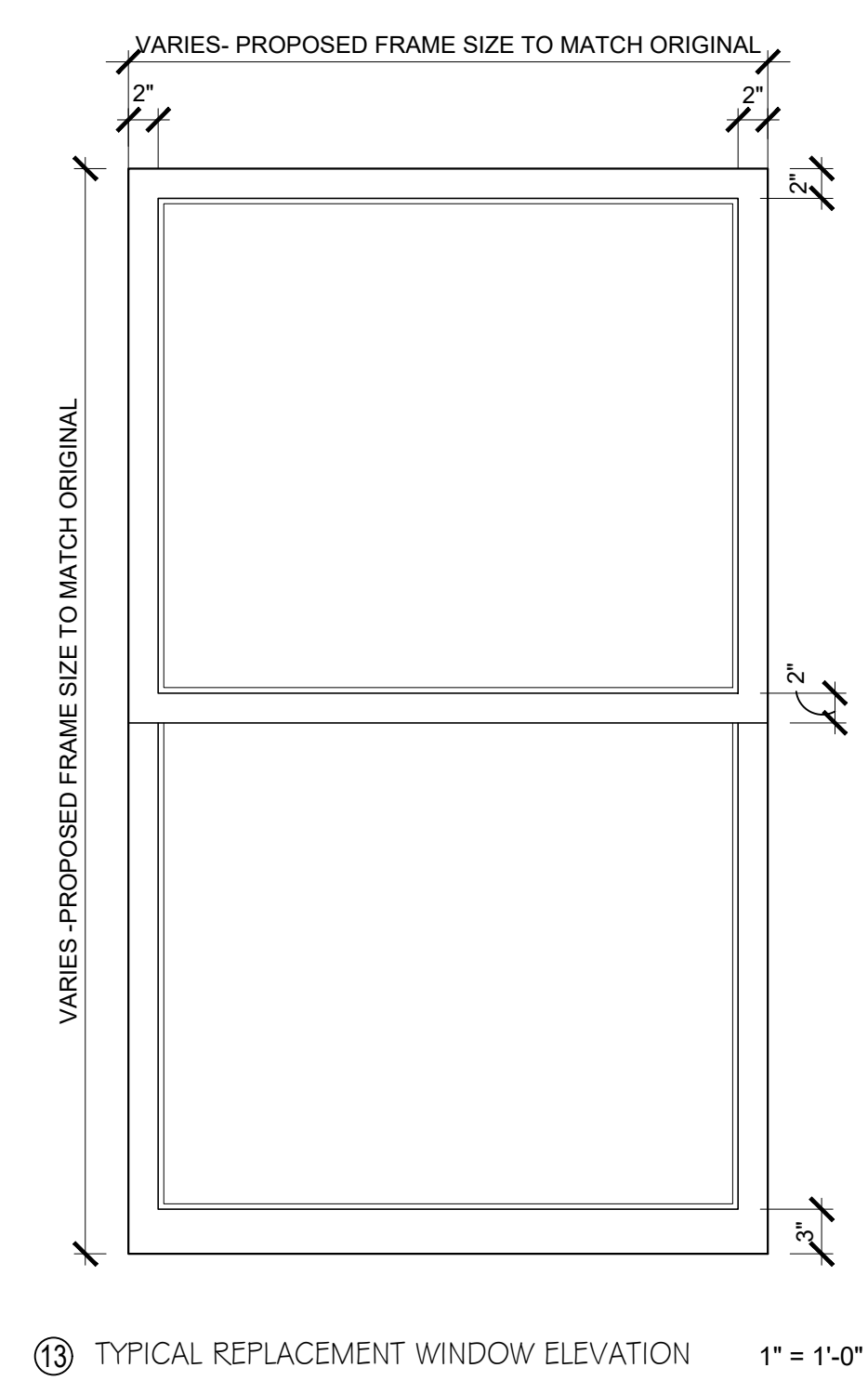
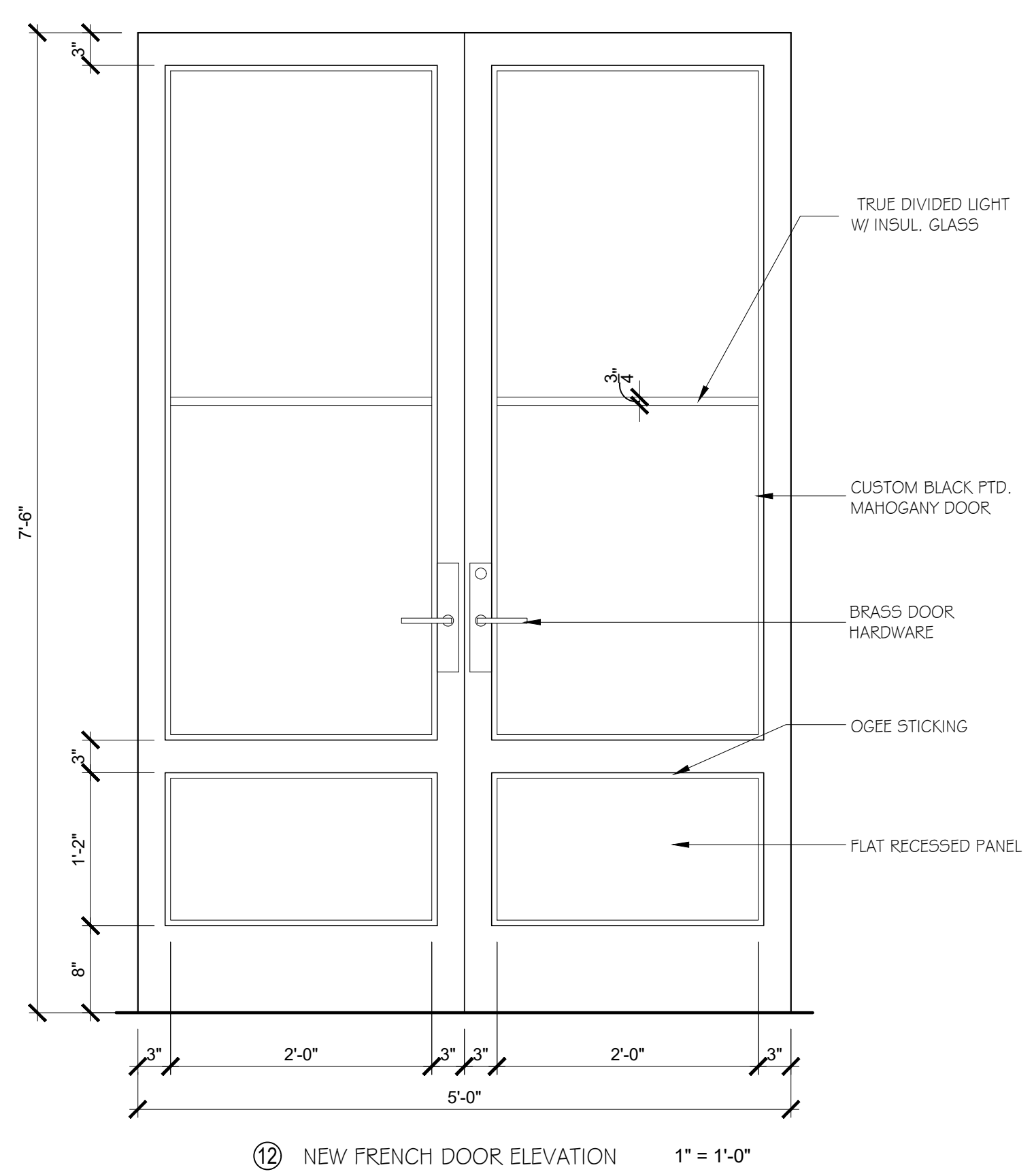
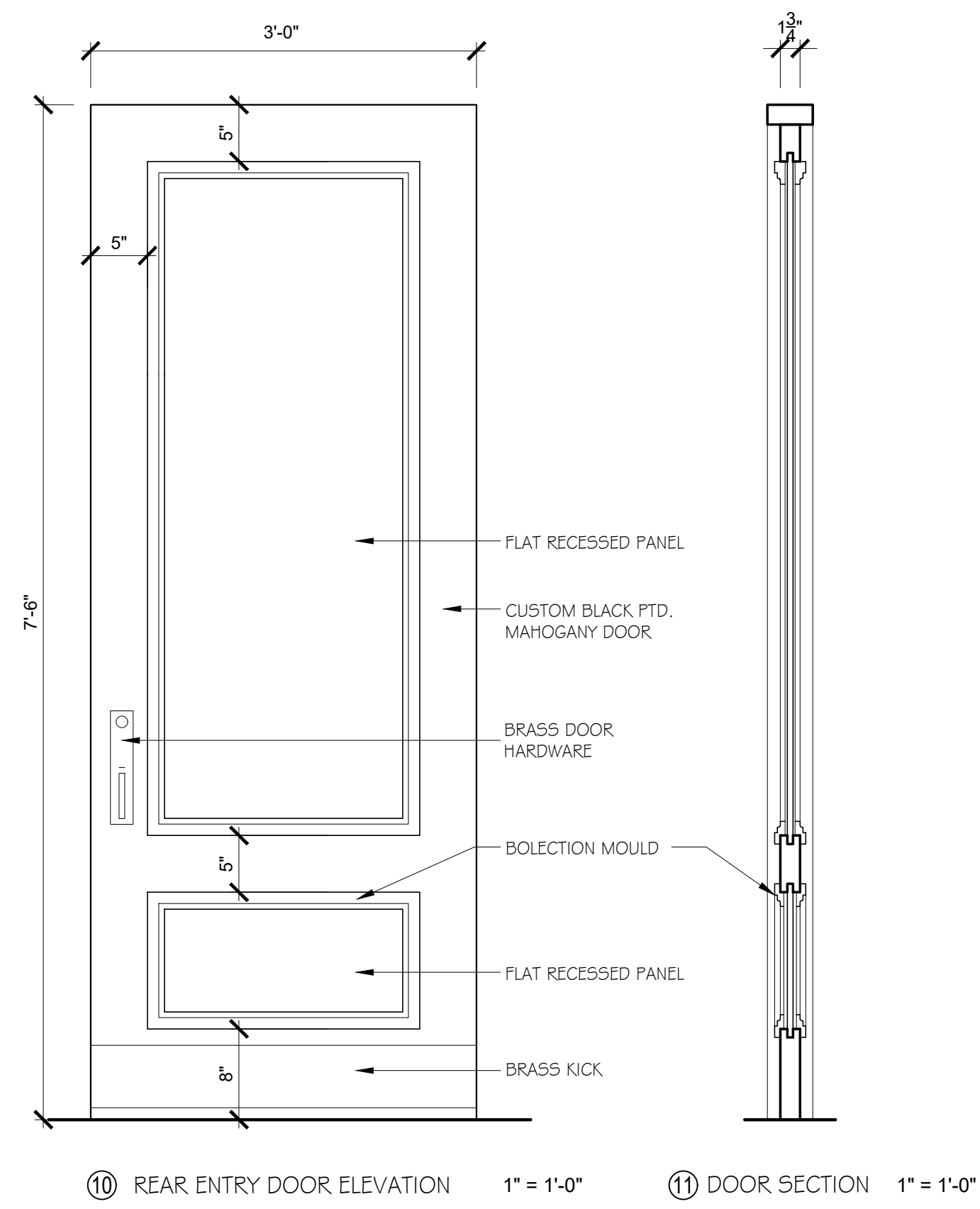

45 Newbury Street, Suite 506
Boston, MA 02116
Phone: 617-956-9992
Fax: 917-956-9993

GRASSI DESIGN GROUP
BEAUCHEMIN GRASSI INTERIORS

GD BG

JOB NO: 2322
SCALE: 1/2" = 1'-0"
DATE: 12.15.23
REVISED

339 MARLBOROUGH STREET
BOSTON, MA

EXTERIOR DETAILS AND DOOR & WINDOW TYPE ELEVATIONS

5



Mock up looking towards Alley 415



Mock up looking towards Marlborough Street



Mock up from Marlborough Street



Mock up looking from Marlborough & Hereford



Mock up looking from Marlborough & Gloucester



Mock up looking from Alley 415 & Gloucester



Mock up from Alley 415



Mock up from Alley 415



Mock up from Alley 415



Mock up looking from Alley 415 & Hereford