



**TRILLIUM BREWING CO.**  
**47 FARNSWORTH STREET RENOVATION**  
*FORT POINT LANDMARKS SUBMISSION SEPTEMBER 20, 2017*



# EXISTING CONDITIONS - THOMSON PLACE PHOTOS

---

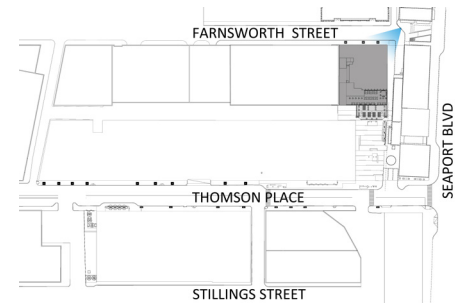

47 FARNSWORTH STREET RENOVATION  
Fort Point - Boston, MA September 20, 2017

Whitlock Design Group  
681 Main Street, Suite 3-31  
Waltham, MA 02451  
(781) 647-8008  
www.whitlockdesigns.com





# EXISTING CONDITIONS - FARNSWORTH STREET PHOTOS

---



VIEW FROM SEAPORT BLVD

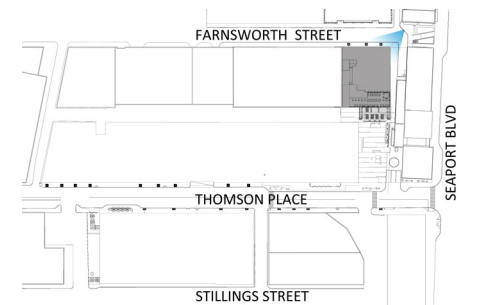

**47 FARNSWORTH STREET RENOVATION**  
Fort Point - Boston, MA      September 20, 2017

**Whitlock Design Group**  
681 Main Street, Suite 3-31  
Waltham, MA 02451  
(781) 647-8008  
[www.whitlockdesigns.com](http://www.whitlockdesigns.com)





# EXISTING CONDITIONS - ROOFTOP PHOTOS

---



THOMSON PLACE VIEW TO ROOF





# 47 FARNSWORTH - HISTORIC PHOTOS

---

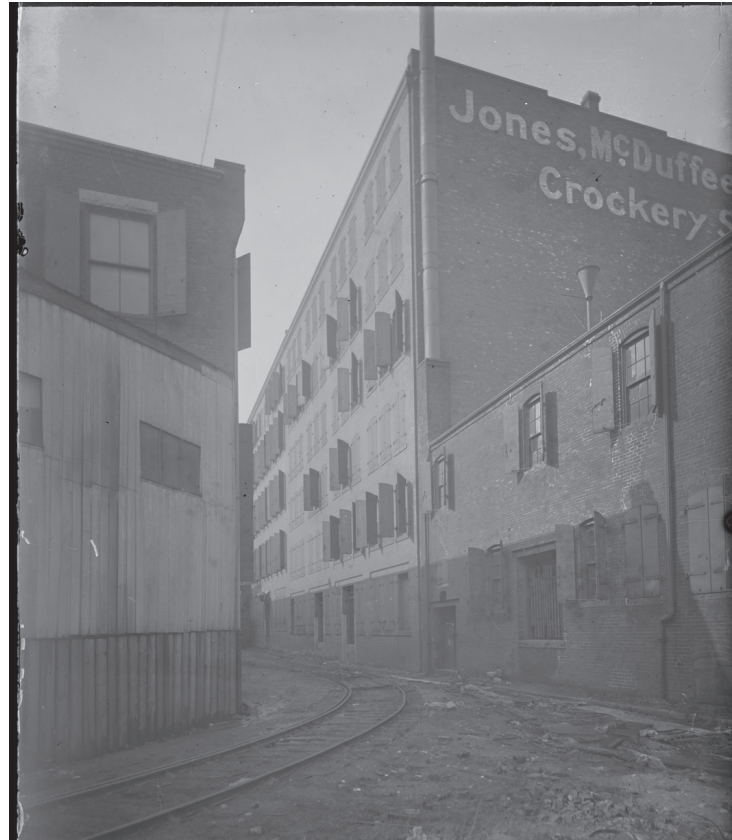

SOUTH FACADE



EAST FACADE



NORTH FACADE



# HISTORIC PHOTOS - AREA SIGNAGE

---



CORNER SIGNAGE



SIGNAGE BAND & SIGNAGE NEXT TO ENTRY DOOR





# HISTORIC PHOTOS - ROOFTOP SIGNAGE

---



BOSTON WHARF COMPANY



NECCO



PROVIDENCE BREWING



# HISTORIC PHOTOS - BREWERIES

---



PABST BREWING



PROVIDENCE BREWING



ROCHESTER BREWING



47 FARNSWORTH STREET RENOVATION  
Fort Point - Boston, MA      September 20, 2017

**Whitlock Design Group**  
681 Main Street, Suite 3-31  
Waltham, MA 02451  
(781) 647-8008  
[www.whitlockdesigns.com](http://www.whitlockdesigns.com)





# HISTORIC PHOTOS & INSPIRATION - ROOF DECK

---



ROOF DECK PAVILION ATOP  
BOSTON WHARF COMPANY



INSPIRATION



# EXISTING CONDITIONS - SITE PLAN

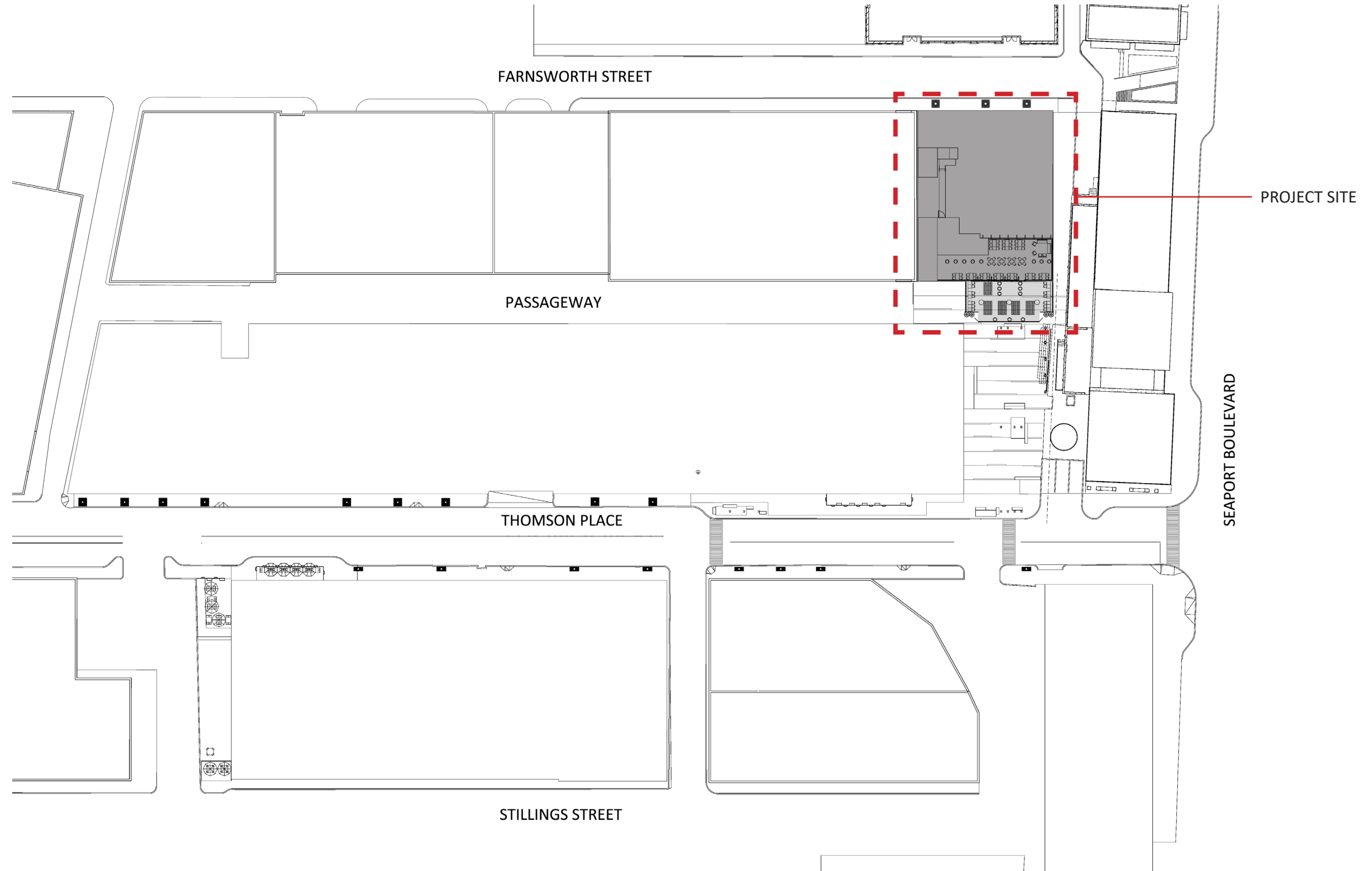



# EXTERIOR MODIFICATIONS - FIRST FLOOR PLAN

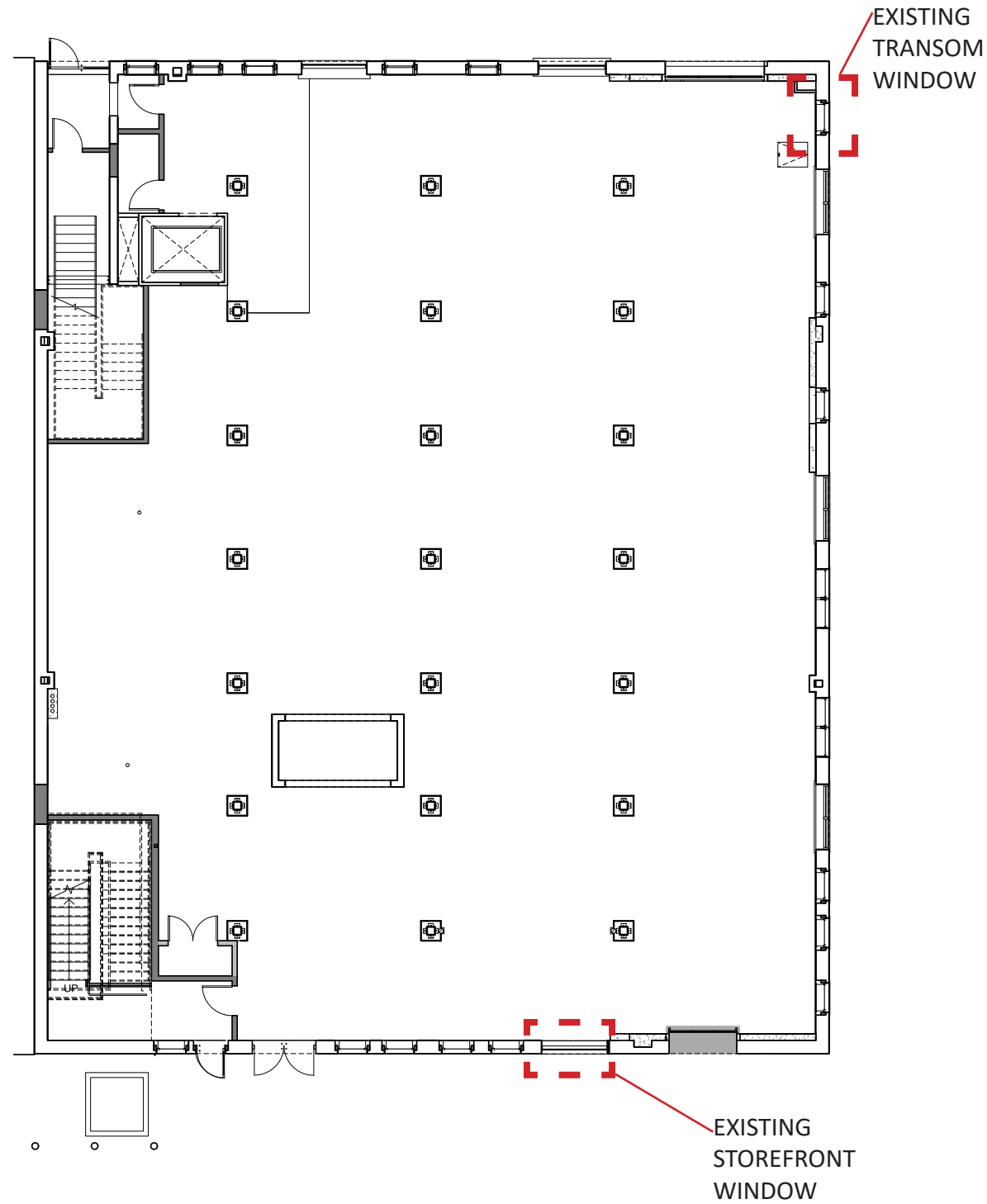

EXISTING CONDITIONS PLAN

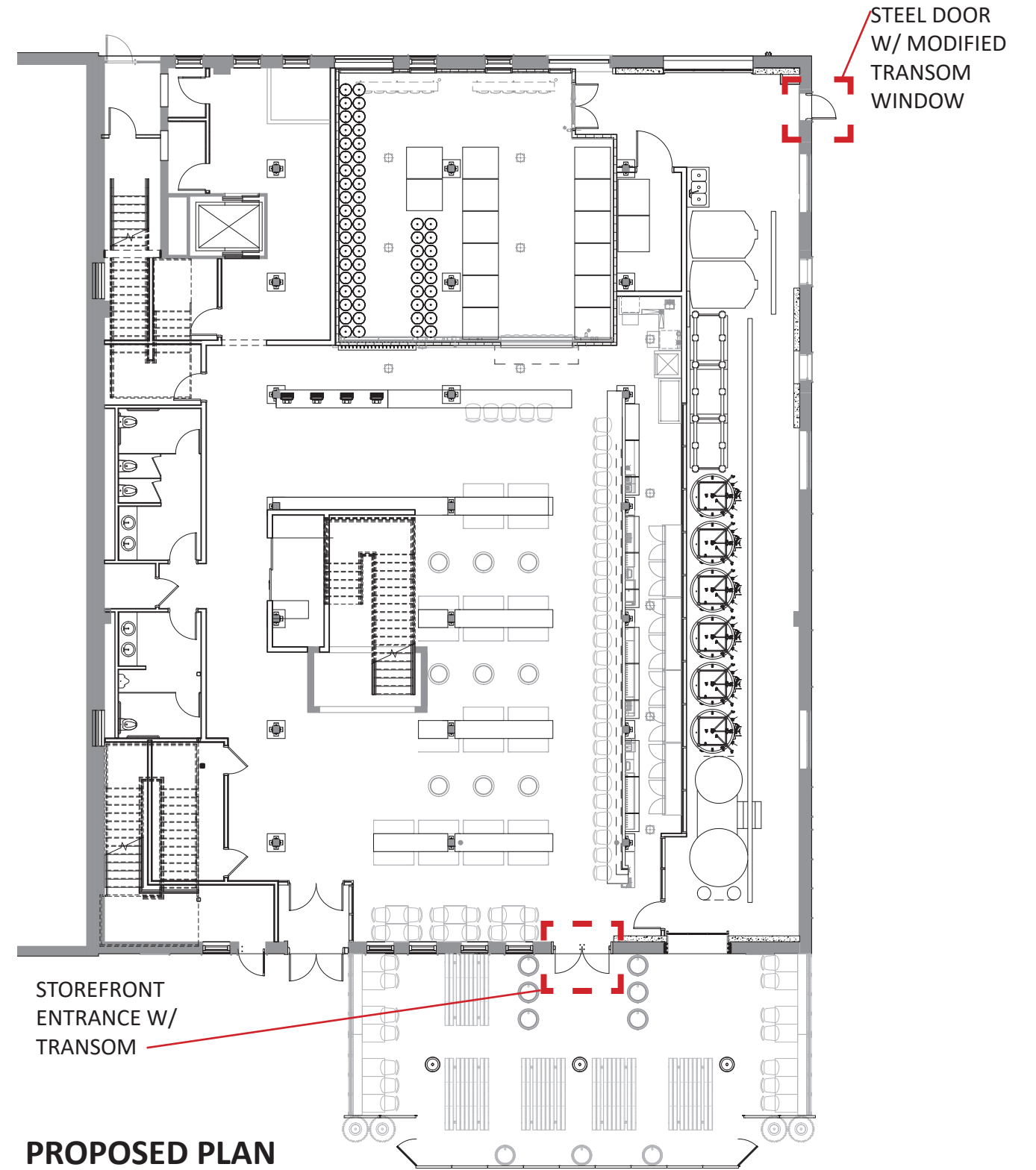

PROPOSED PLAN



# EXTERIOR MODIFICATIONS - ROOF DECK PLAN

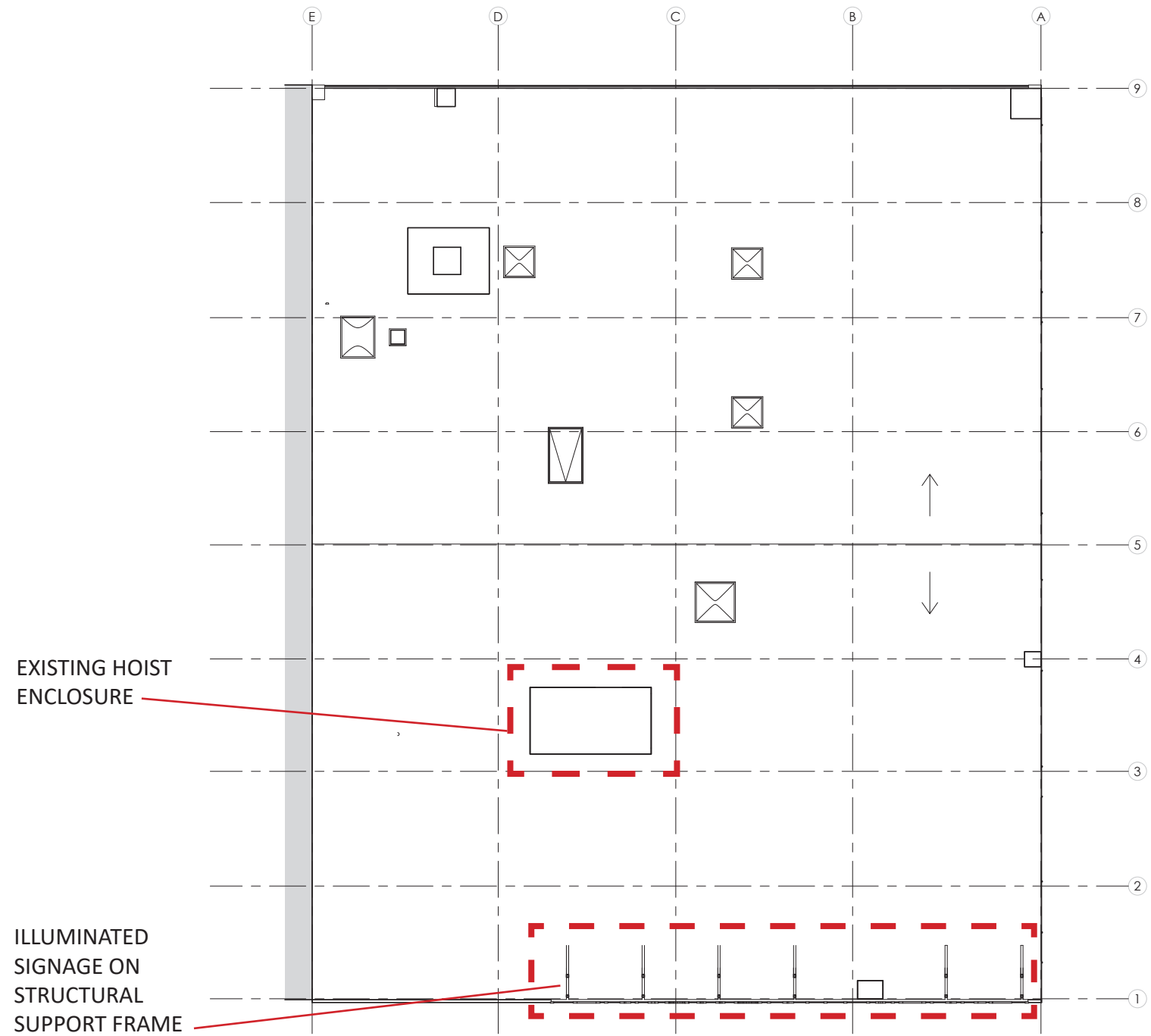

**EXISTING CONDITIONS PLAN**

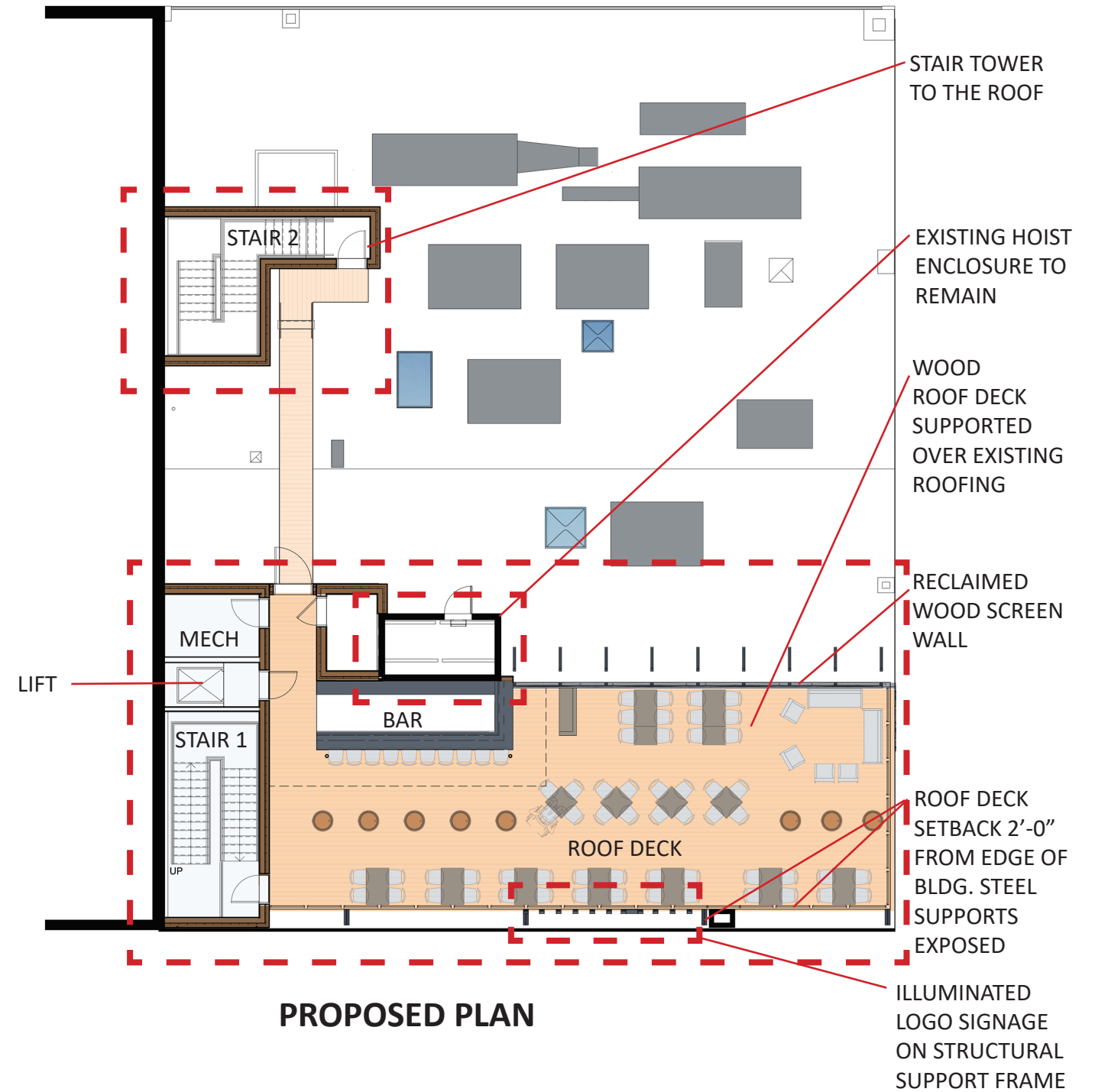

**PROPOSED PLAN**



# EXTERIOR MODIFICATIONS - ROOF DECK SECTION

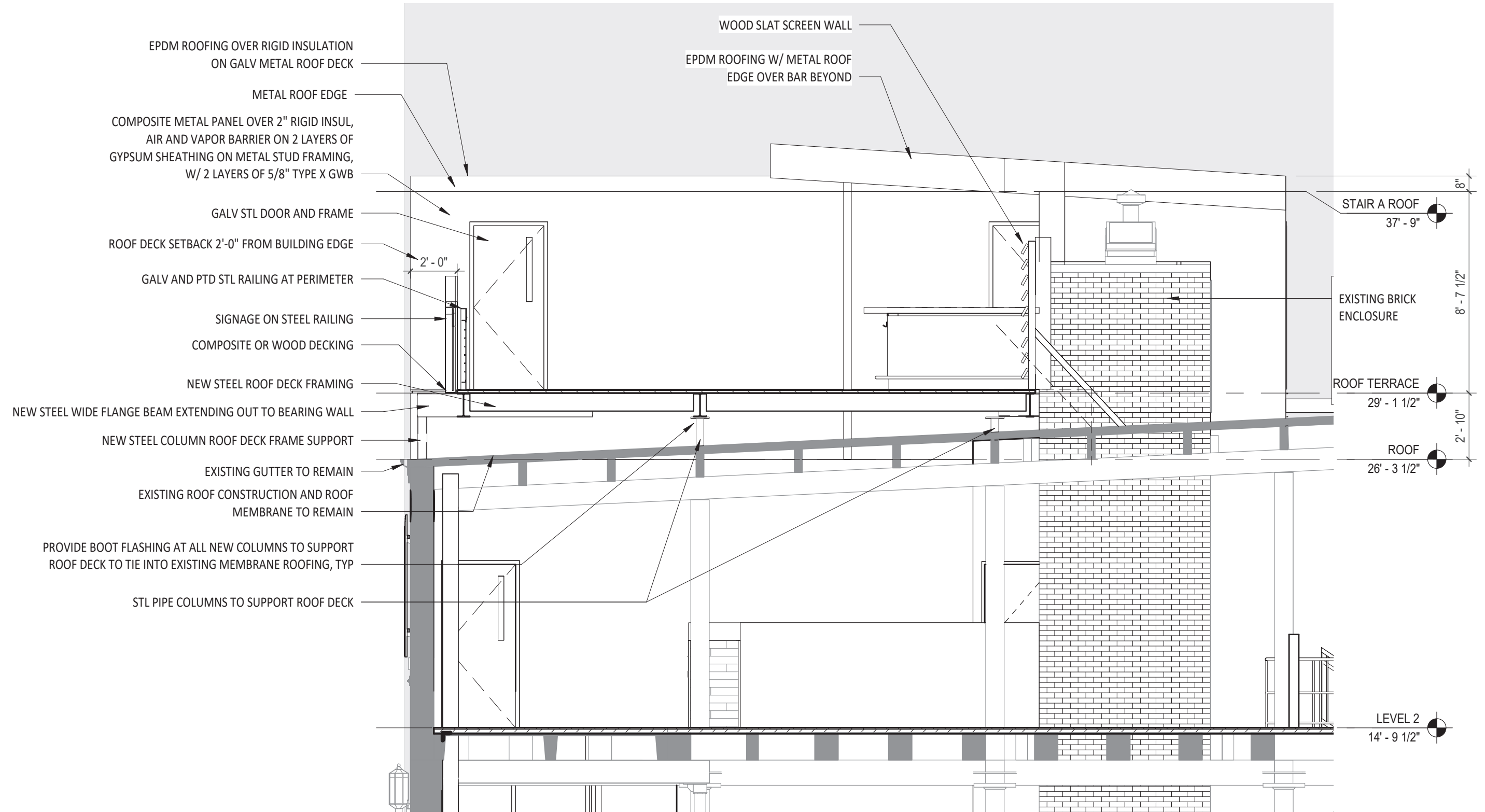



# EXTERIOR MODIFICATIONS - SITE SECTION

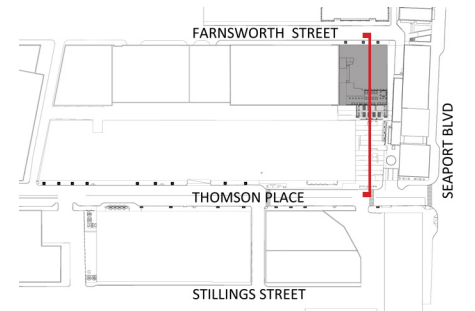
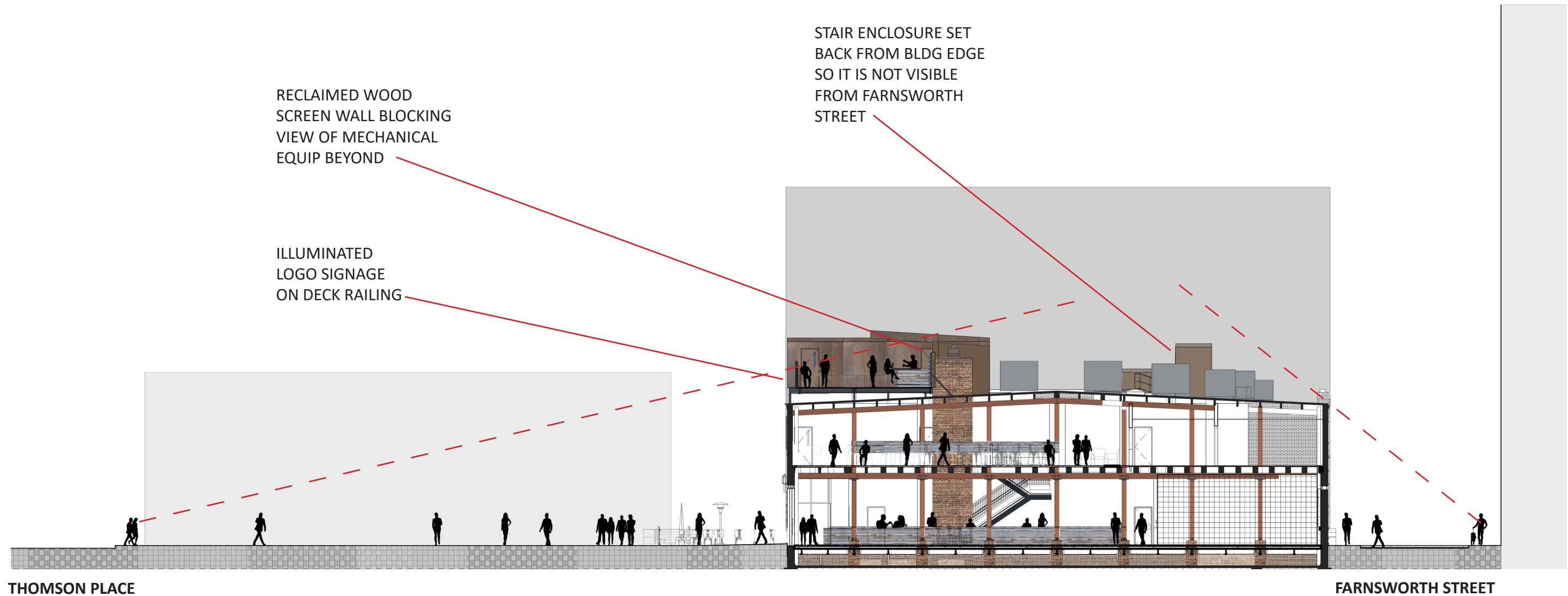

47 FARNSWORTH STREET RENOVATION  
Fort Point - Boston, MA September 20, 2017

Whitlock Design Group  
681 Main Street, Suite 3-31  
Waltham, MA 02451  
(781) 647-8008  
www.whitlockdesigns.com





# EXTERIOR MODIFICATIONS - EXISTING SOUTH ELEVATION

---



EXISTING CONDITIONS ELEVATION



# EXTERIOR MODIFICATIONS - PROPOSED SOUTH ELEVATION



PROPOSED ELEVATION



# EXTERIOR MODIFICATIONS - PROPOSED EAST ELEVATION





# EXTERIOR MODIFICATIONS - EXISTING NORTH ELEVATION

---



EXISTING CONDITIONS ELEVATION



# EXTERIOR MODIFICATIONS - PROPOSED NORTH ELEVATION

---



PROPOSED ELEVATION



# EXTERIOR MODIFICATIONS - EXISTING AND PROPOSED SOUTH ELEVATION



EXISTING CONDITIONS ELEVATION

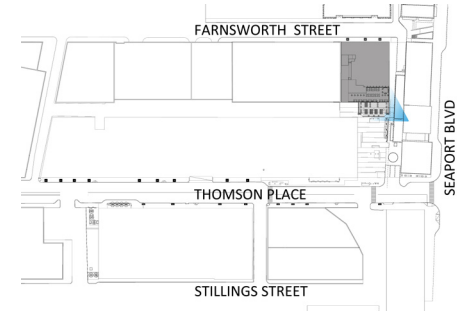

PROPOSED ELEVATION



47 FARNSWORTH STREET RENOVATION  
Fort Point - Boston, MA      September 20, 2017

Whitlock Design Group  
681 Main Street, Suite 3-31  
Waltham, MA 02451  
(781) 647-8008  
www.whitlockdesigns.com





# EXTERIOR MODIFICATIONS - EXISTING AND PROPOSED NORTH ELEVATION



EXISTING CONDITIONS ELEVATION



PROPOSED ELEVATION





# EXTERIOR MODIFICATIONS - VIEW FROM FARNSWORTH STREET



47 FARNSWORTH STREET RENOVATION  
Fort Point - Boston, MA September 20, 2017

Whitlock Design Group  
681 Main Street, Suite 3-31  
Waltham, MA 02451  
(781) 647-8008  
www.whitlockdesigns.com





# EXTERIOR MODIFICATIONS - VIEW FROM THOMSON PLACE



Whitlock  
DESIGN GROUP



**47 FARNSWORTH STREET RENOVATION**  
Fort Point - Boston, MA      September 20, 2017

**Whitlock Design Group**  
681 Main Street, Suite 3-31  
Waltham, MA 02451  
(781) 647-8008  
[www.whitlockdesigns.com](http://www.whitlockdesigns.com)





# EXTERIOR MODIFICATIONS - VIEW FROM PLAZA



47 FARNSWORTH STREET RENOVATION  
Fort Point - Boston, MA September 20, 2017

Whitlock Design Group  
681 Main Street, Suite 3-31  
Waltham, MA 02451  
(781) 647-8008  
www.whitlockdesigns.com





# AERIAL VIEW OF PLAZA - EXISTING

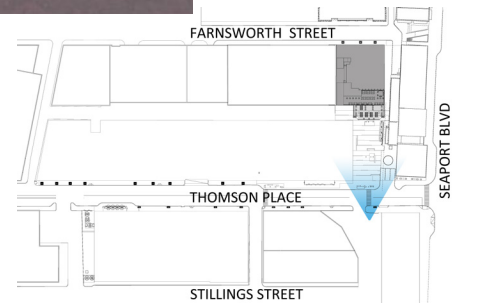



# AERIAL VIEW OF PLAZA - PROPOSED

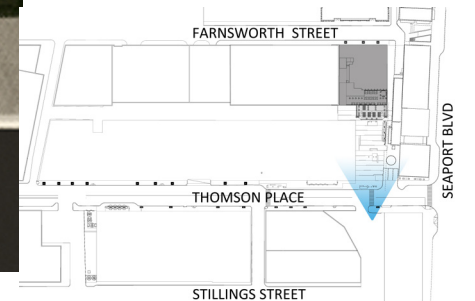

47 FARNSWORTH STREET RENOVATION  
Fort Point - Boston, MA September 20, 2017

Whitlock Design Group  
681 Main Street, Suite 3-31  
Waltham, MA 02451  
(781) 647-8008  
www.whitlockdesigns.com





# ROOF MOCKUP PHOTOS



VIEW 1 - DOWN FARNSWORTH STREET



VIEW 2 - FROM PASSAGEWAY



VIEW 3 - FROM THOMSON PLACE



VIEW 4 - FROM STAIRS AT SEAPORT BOULEVARD

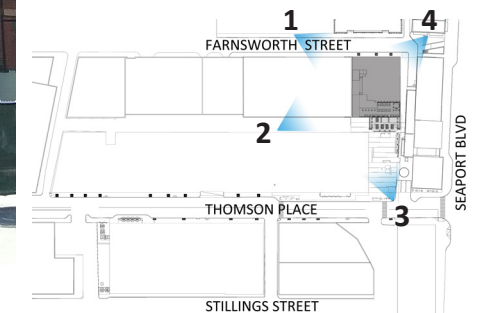



# ROOF MOCKUP PHOTOS



VIEW 1 - FROM RAMP AT SEAPORT BOULEVARD



VIEW 2 - FROM MBTA VENT STACK



VIEW 3 - FROM PARKING LOT ACROSS THOMSON PLACE



VIEW 4 - FROM CORNER OF SHAKE SHACK

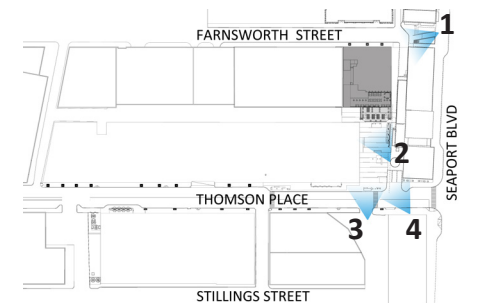



# EXTERIOR MODIFICATIONS - ROOF TERRACE RAILING

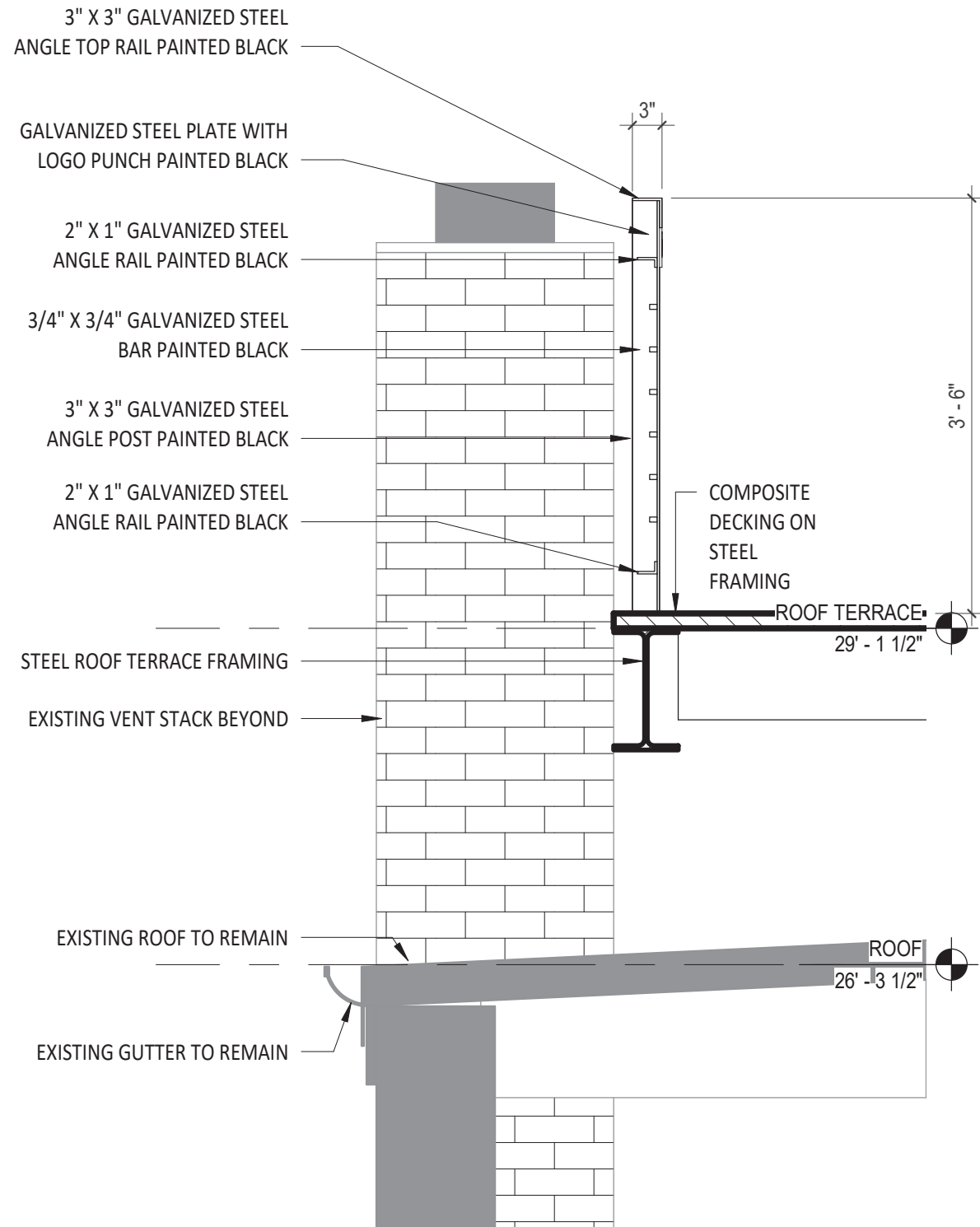

SECTION DETAIL

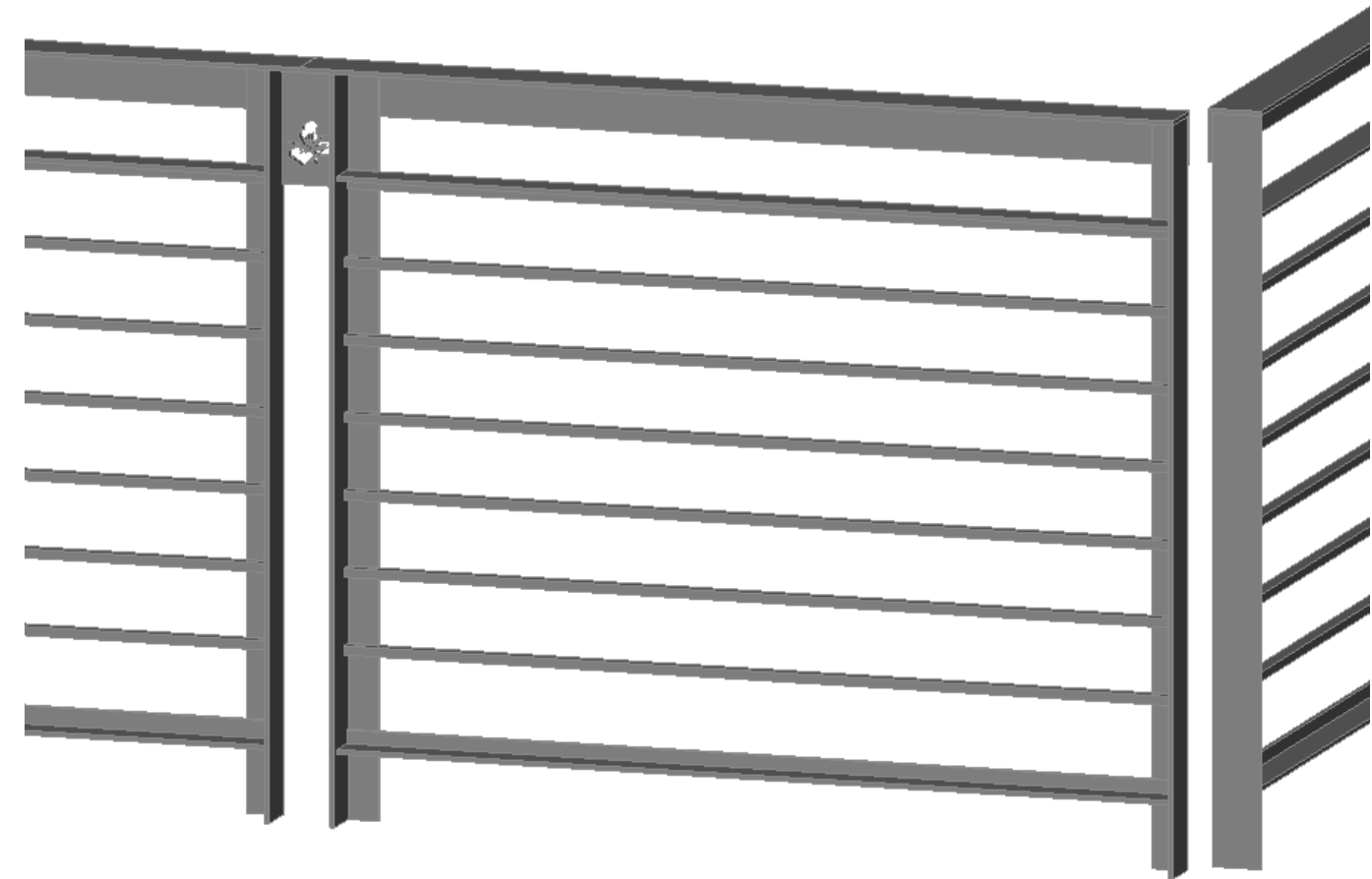

3D MODEL VIEW



# EXTERIOR MODIFICATIONS - ROOF TERRACE WOOD SCREEN

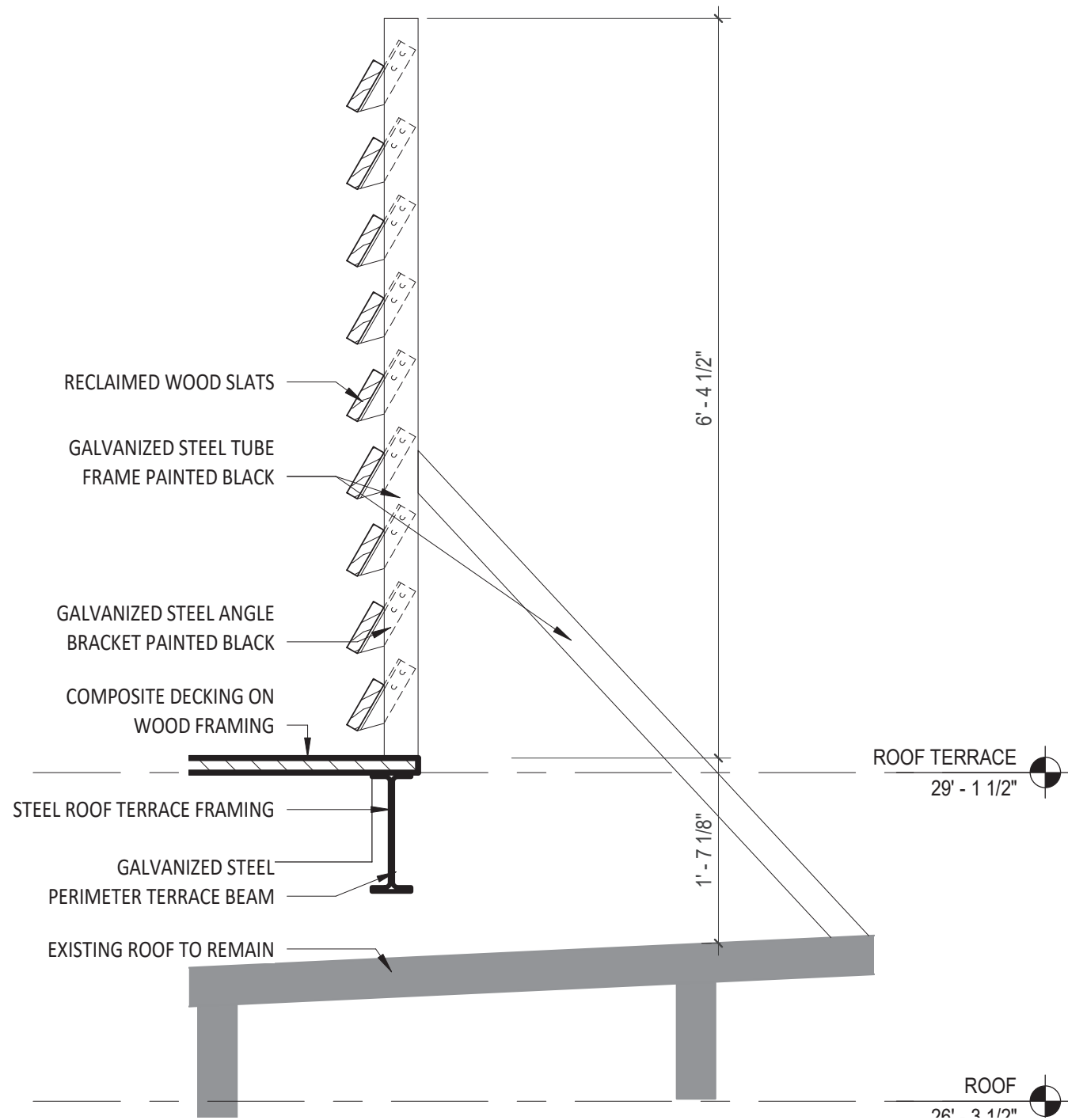

SECTION DETAIL

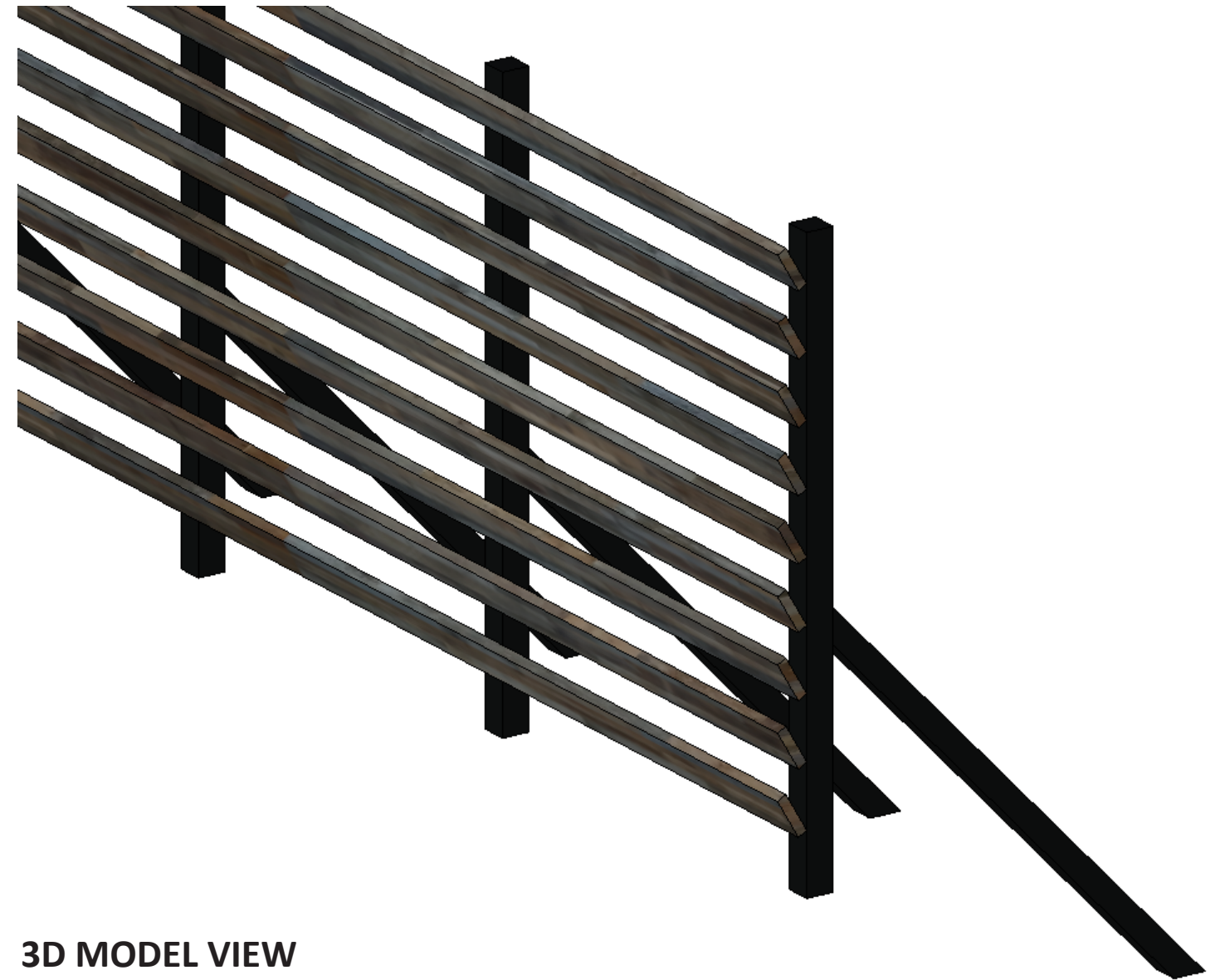



# EXTERIOR MODIFICATIONS - ROOF TERRACE SIGNAGE DETAIL

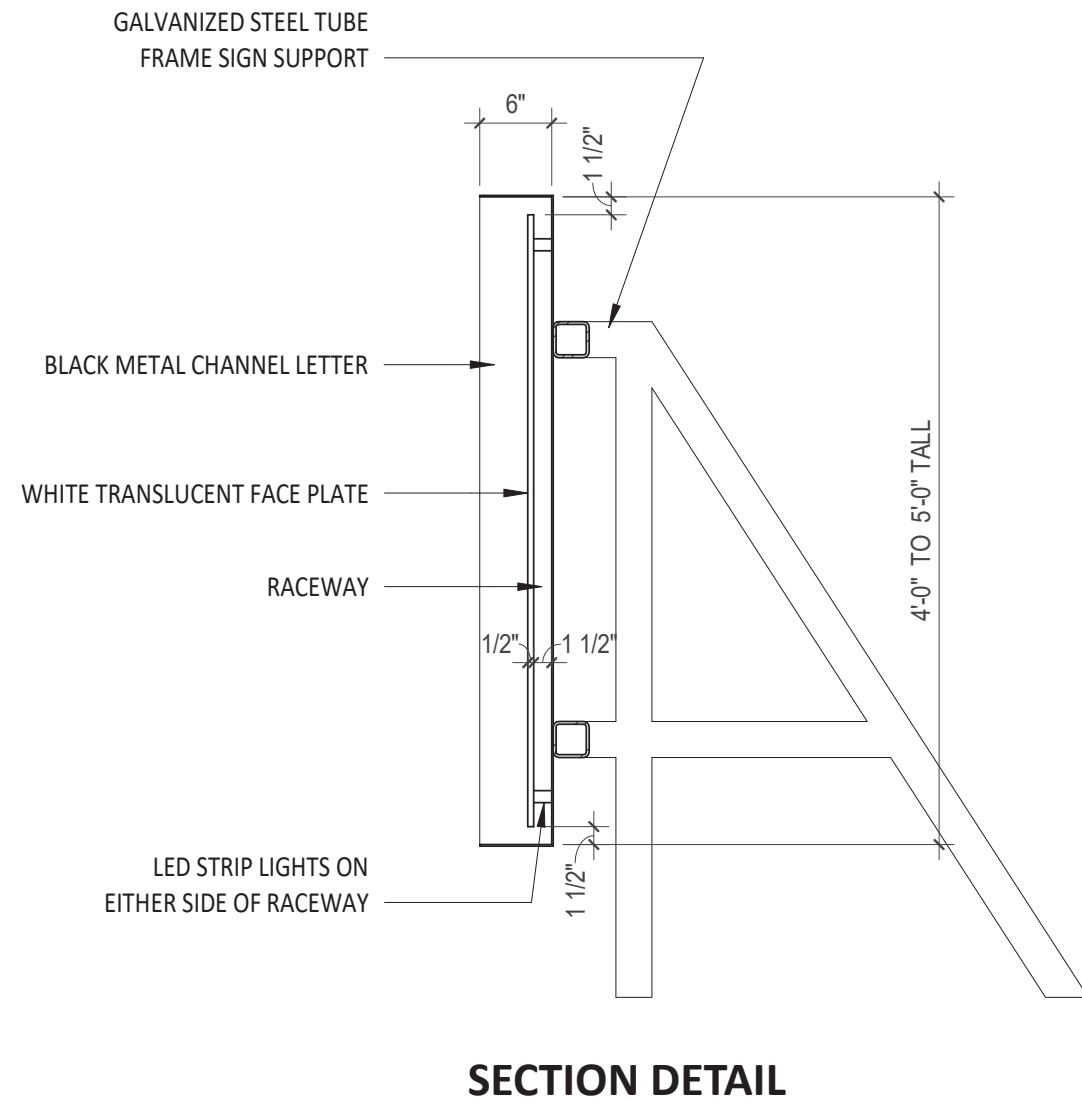

**SECTION DETAIL**

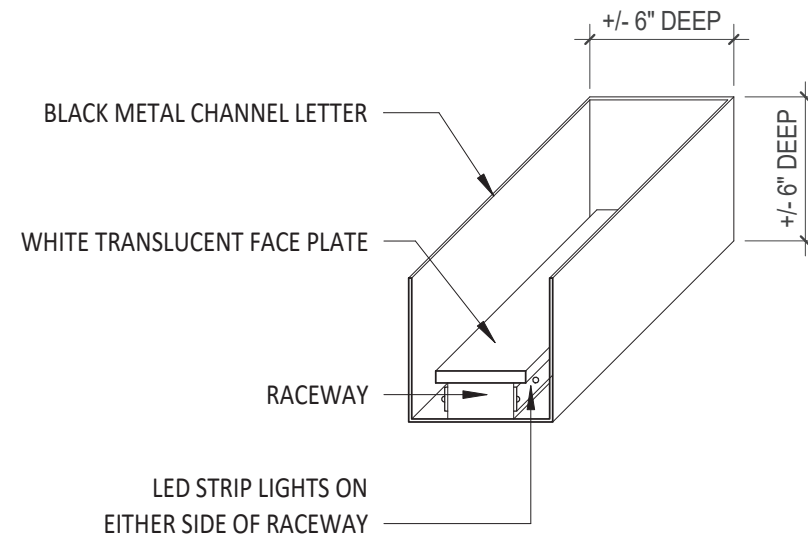

**SECTION AXON VIEW**

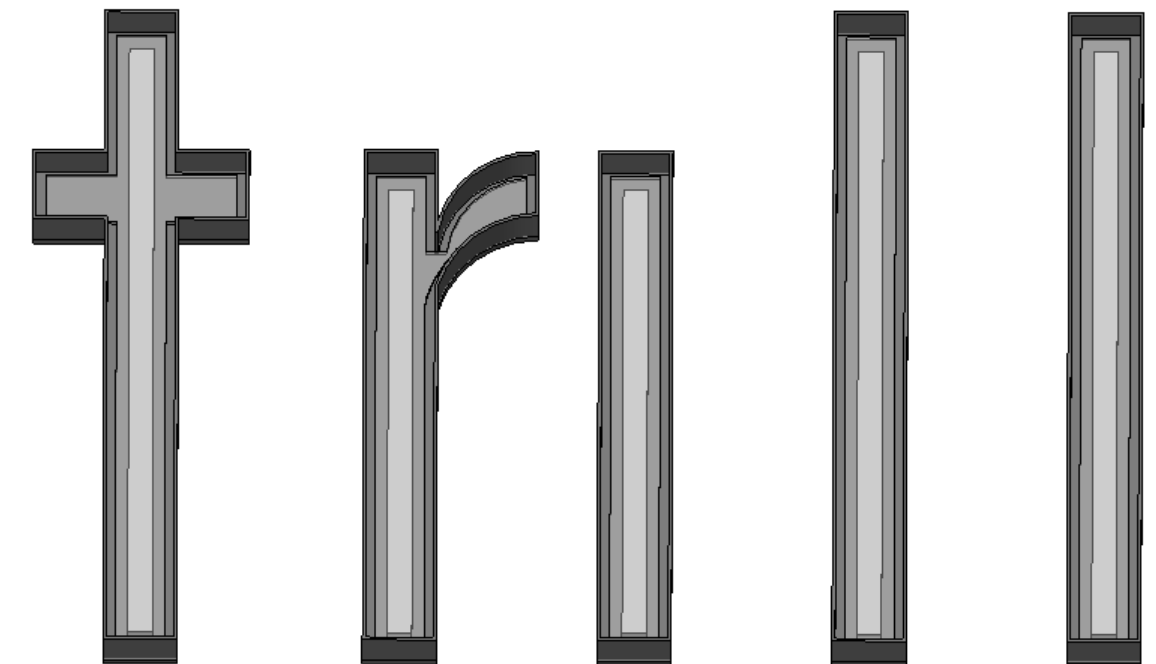

**3D MODEL VIEW**



# EXTERIOR MODIFICATIONS - PATIO DETAILS

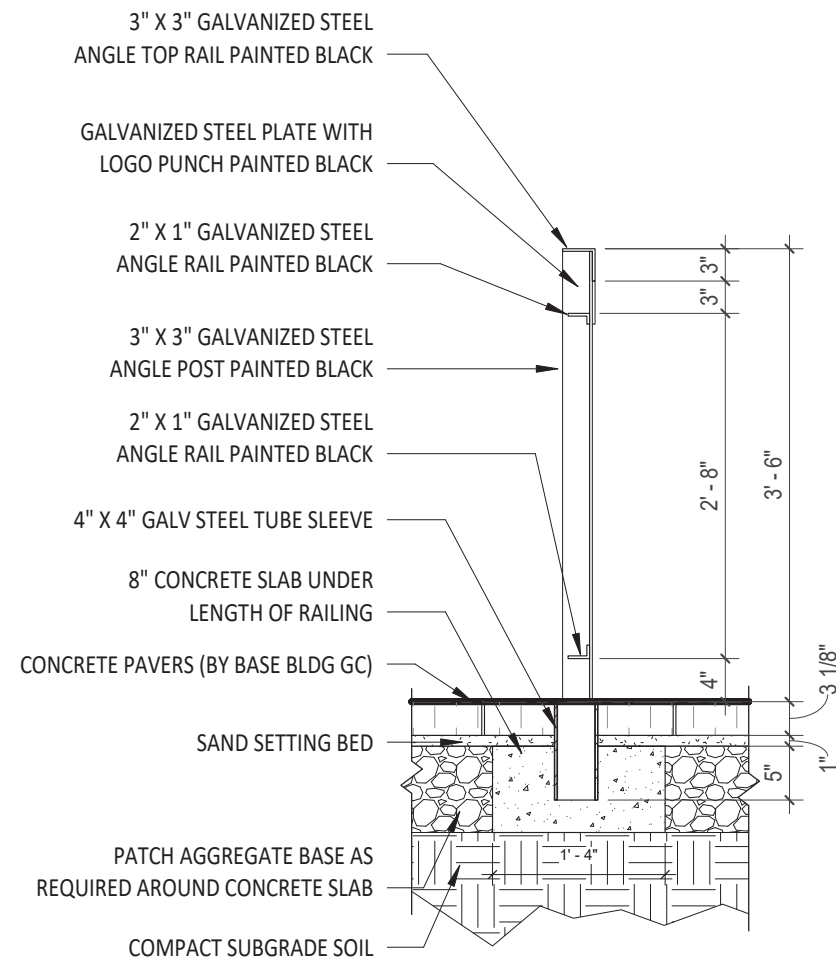

REMOVABLE RAILING SECTION DETAIL

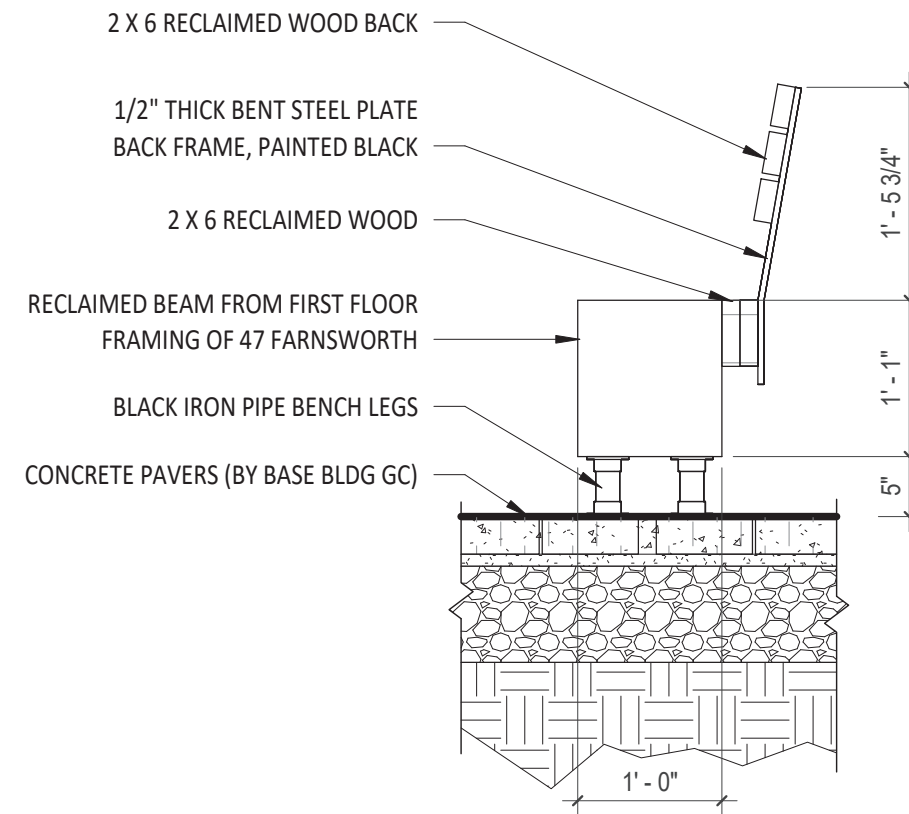

BENCH SECTION DETAIL

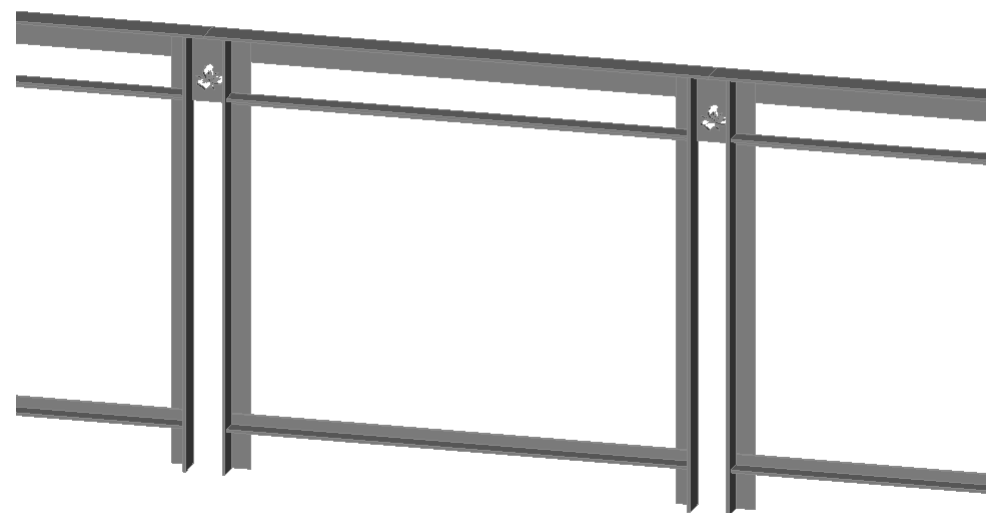

REMOVABLE RAILING 3D MODEL VIEW



BENCH 3D MODEL VIEW



# EXTERIOR FURNITURE





# ROOF DECK

